

Heating and District Heating Controller

EQJW126F001
P100019096

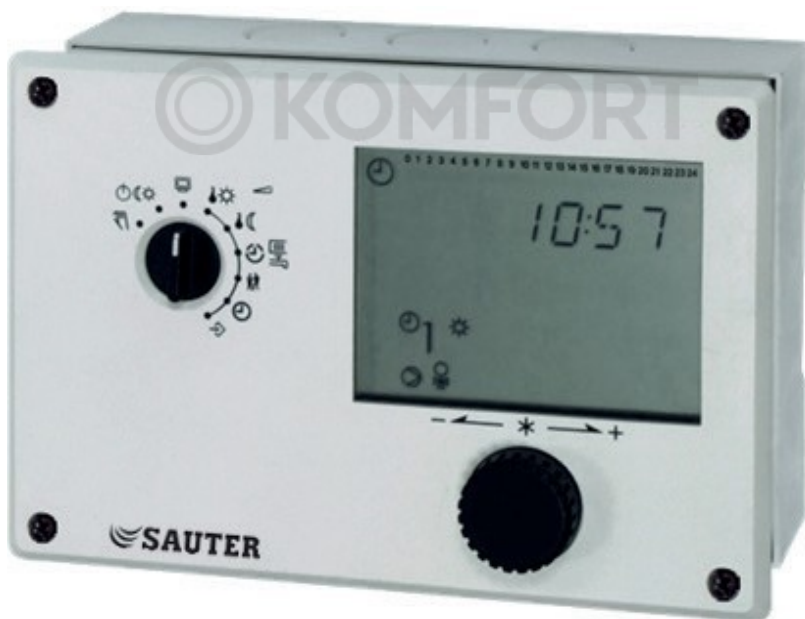



Mounting and Operating Instructions

Firmwareversion 2.34

Important safety instructions

For your own safety, observe the following instructions on the installation, start up and operation of the controller:

-  The device may only be installed, started up or operated by trained and experienced personnel familiar with the product.
-  The controller has been designed for use in electrical power systems. For wiring and maintenance, you are required to observe the relevant safety regulations.

In addition, the following applies to prevent damage to the controller:

-  Proper shipping and appropriate storage are assumed.



Definitions of the signal words used in these instructions

DANGER!

indicates a hazardous situation which, if not avoided, will result in death or serious injury.

NOTICE

indicates a property damage message.

Note: *Supplementary explanations, information and tips*

WARNING!

indicates a hazardous situation which, if not avoided, could result in death or serious injury.

ContentsPage

1	Operation	5
1.1	Operating controls	5
1.1.1	Rotary pushbutton.....	5
1.1.2	Rotary switch	5
1.2	Operating modes.....	6
1.2.1	Setting the operating modes.....	6
1.3	Display	7
1.4	Opening the information level	8
1.5	Setting the controller time.....	9
1.6	Setting the times-of-use	10
1.7	Setting the party mode	11
1.8	Activating the extended information level.....	12
1.8.1	Setting public holidays.....	13
1.8.2	Setting vacation periods.....	14
1.9	Entering day and night set points.....	16
2	Start-up	18
2.1	Activating and deactivating functions	18
2.2	Changing parameters.....	20
2.3	Calibrating sensors	21
2.4	Resetting to default values	22
3	Manual operation	23
4	Hydraulic system	24
5	Functions of the heating circuit	25
5.1	Weather-compensated control.....	25
5.1.1	Gradient characteristic	26
5.1.2	Four-point characteristic	28
5.2	Fixed set point control.....	29
5.3	Underfloor heating/drying of jointless floors.....	29
5.4	Deactivation depending on outdoor temperature	31
5.4.1	OT deactivation value in rated operation	31
5.4.2	OT deactivation value in reduced operation	32
5.4.3	OT activation value in rated operation	32
5.4.4	Summer mode	32
5.5	Delayed outdoor temperature adaptation	33
5.6	Optimization	34
5.7	Flash adaptation	35
5.7.1	Flash adaptation without outdoor sensor	35

5.9 Cooling control..... 37

6 System-wide functions39

6.1 Automatic summer time/winter time changeover..... 39

6.2 Frost protection 39

6.3 Forced operation of the pumps..... 39

6.4 Return flow temperature limitation 40

6.5 Condensate accumulation control..... 41

6.6 Three-step control 42

6.7 On/off control..... 42

6.8 Continuous control in control circuit Rk1 42

6.9 Locking manual level 43

6.10 Locking the rotary switch..... 44

6.11 Setting a customized key number..... 44

7 Operational faults.....45

7.1 Error list..... 45

7.2 Sensor failure 46

7.3 Temperature monitoring..... 46

7.4 Error status register 46

7.5 Sending text messages in case of error..... 47

8 Communication49

8.1 RS-232/modem communications module..... 50

8.2 RS-485 communications module..... 51

8.3 Description of communication parameter settings..... 52

8.4 Meter bus/Modbus gateway 53

8.4.1 Activating the meter bus..... 53

8.4.2 Flow rate and/or capacity limitation using meter bus 54

8.5 Memory module..... 56

8.6 Data logging..... 56

9 Installation57

10 Electrical connection60

12 Appendix.....65

12.1 Function block lists 65

12.2 Parameter lists..... 71

12.3 Sensor resistance tables..... 77

12.4 Technical data 79



1 Operation

The controller is ready for use with the default temperatures and operating schedules. On start-up, the **current time and date** need to be set at the controller (-> section 1.5).

1.1 Operating controls

The operating controls are located in the front panel of the controller.

1.1.1 Rotary pushbutton

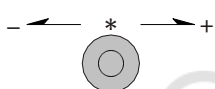

Rotary pushbutton

Turn []:

Display, select parameters and function blocks



Press [*]:

Confirm adjusted selection or settings



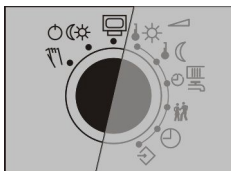



1.1.2 Rotary switch

The rotary switch is used to set the operating mode and the relevant parameters for each control circuit.



-  Information level, rotary switch in normal position
-  Operating modes
-  Manual level



-  Day set point (rated room temperature)
-  Night set point (reduced room temperature)
-  Times-of-use for
 -  heating Party mode
-  Controller time
-  Configuration and parameter level

1.2 Operating modes

Day mode (rated operation) : Regardless of the programmed times-of-use and summer mode, the set points relevant for rated operation are used by the controller.









Night mode (reduced operation) : Regardless of the programmed times-of-use, the set points relevant for reduced operation are used by the controller.

Stand-by mode : Regardless of the programmed times-of-use, control operation is deactivated. Only the frost protection is activated, if need be.

Automatic mode : During the programmed times-of-use, the controller works in rated operation. Outside these times-of-use, the controller is in reduced operation, unless control operation is deactivated depending on the outdoor temperature. The controller switches automatically between both operating modes.

Manual mode : Valves and pumps can be controlled manually (→ section 3).

1.2.1 Setting the operating modes

1. Turn the rotary switch to  (operating modes)  blinks on the display.
2. Select the operating mode [, ,  or ]:
3. Confirm the operating mode .
4. Return the rotary switch to normal switch position  (information level).

Note: In automatic mode, the momentary stage of the operating schedule ( for day mode or  for night mode) is displayed in the information level together with the icon .

1.3 Display

The display indicates the time as well as information about the operation of the controller when the rotary switch is at the normal position (information level). The times-of-use together with temperatures of the various control circuits can be viewed on the display by turning the rotary pushbutton. The times-of-use are represented by black squares below the row of numbers at the top of the display. Icons indicate the operating status of the controller.

 Public holiday mode

 Vacation mode

 Operational

 Frost protection





1 Heating circuit 1 

 Automatic mode

 Night mode

 Day mode

 Manual mode

 Stand-by mode

 Circulation pump

 UP1* Valve Rk1 opening



 Valve Rk1 closing

Fig. 1 · Icons









The controller status can be displayed in the information level (→ section 1.4).

1.4 Opening the information level

At the normal switch position  (information level), the time, date, public holidays and vacation periods as well as the temperatures measured by the connected sensors and their set points can be retrieved and displayed.

Note: Data can also be viewed in the operating level  (manual mode). To do so, select **Info**, confirm and proceed as described below.

Proceed as follows:

- Select value [9].
Depending on the configuration of the controller, the current values of the following data points are displayed one after the other:
 -  Time
 -  Room temperature, heating circuit
 -  Outdoor temperature
 -  Temperature at flow sensor VF, heating circuit
 -  Temperature at return flow sensor RÜF
- By confirming a data point  its set point/limit is displayed. When the time is indicated on the display, the date appears on pressing the rotary pushbutton.

1.5 Setting the controller time

The current time and date need to be set immediately after start-up and after a power failure of more than 24 hours has occurred. This is the case when the time blinks on the display.

Proceed as follows:

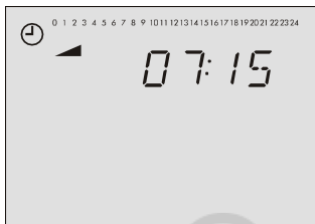

1. Turn the rotary switch to ⌚ (controller time). Display: time, ⌚ and blink.
2. Edit the controller time [⏪].



3. Confirm the adjusted time ✱. Display: year
4. Edit the year [⏪].

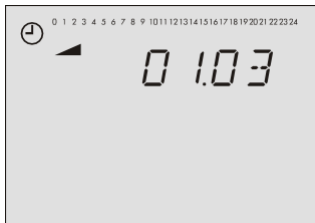

5. Confirm the adjusted year ✱. Display: date (day.month)
6. Edit the date [⏪].
7. Confirm the adjusted date ✱. Display: time
8. Return the rotary switch to normal switch position (information level).

Note: The correct time is guaranteed after a power failure of 24 hours. Normally, the correct time is still retained at least 48 hours after a power failure.

1.6 Setting the times-of-use

Three times-of-use can be set for each day of the week.

Parameters	WE*	Range of values
Period/day	1-7	1-7, 1, 2, 3, 4, 5, 6, 7 with 1-7 = every day, 1 = Monday, 2 = Tuesday, ..., 7 = Sunday
Start first time-of-use	6:00	0:00 to 24:00h; in steps of 15 minutes
Stop first time-of-use	22:00	0:00 to 24:00h; in steps of 15 minutes
Start second time-of-use	22:15	0:00 to 24:00h; in steps of 15 minutes
Stop second time-of-use	22:15	0:00 to 24:00h; in steps of 15 minutes
Start third time-of-use	-	0:00 to 24:00h; in steps of 15 minutes
Stop third time-of-use	-	0:00 to 24:00h; in steps of 15 minutes

* Default values (WE) valid for heating circuits

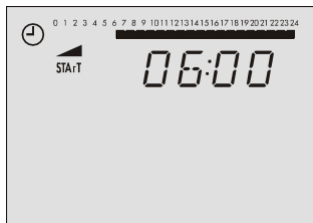
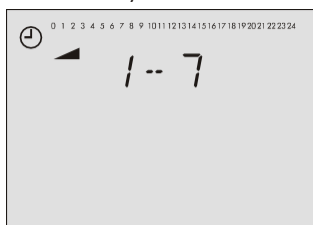

Proceed as follows:

1. Turn the rotary switch to  (times-of-use). blinks.



2. Select period/day for which the times-of-use are

to be valid []:
1-7 = every day,

3. Activate editing mode for period/day
Display: **START**,  and  blink.
4. Edit start time
(in steps of 15



5. Confirm start time [1].

Display: **STOP**

6. Edit stop time [9].
(in steps of 15 minutes)

7. Confirm stop time [1].

Display: **START**

The indicated time corresponds to the stop time for the first time-of-use plus 15 minutes.

To set the second and third times-of-use, repeat steps 5 to 7.

If no further times-of-use for the selected period/day are to be programmed, confirm the displayed start time twice (2x [1]).

For daily setting, repeat steps 2 to 7 in the same sequence.

Note: Do not use the 1–7 menu to check the programmed times-of-use. If this menu is opened after the times-of-use have been set, the schedule programmed for Monday is also adopted for all other days of the week.

8. After setting all times-of-use:
Return the rotary switch to normal switch position [0] (information level).

1.7 Setting the party mode

Using the **Party mode** function, the controller continues or activates the day mode during the time when the party timer is active, regardless of the programmed times-of-use. When the party timer has elapsed, the party mode timer is reset to 00:00.

Parameter	WE	Range of values
Continue/active rate operation te d	0 h	0 to 48 hours

Proceed as follows:

1. Turn the rotary switch to [1] (party mode). blinks.

Display: **00:00** or indicates the remaining time of party timer.

2. Select how long the day mode is to continue running [9]. This setting is made in steps of 15 minutes.
3. Return the rotary switch to normal switch position  (information level).

Note: The party timer counts down in steps of 15 minutes.

1.8 Activating the extended information level

If the extended information level is activated, further information can be viewed after the listed data points:

 Capacity

 Flow rate \dot{V}

 Public holidays (can be changed, see section 1.8.1)

 Vacation periods (can be changed, see section 1.8.2)

 Valve positions

 Switching states of the binary inputs

 InFo 2: After confirming the level [] the following data appear in the sequences shown below:





Controller ID

Memory capacity of data logging module (section 8.6) 255

Operating hours of solar circuit pump (refer to section 6.4)

Opening the extended information level:

1. Turn the rotary switch to (parameter and configuration level). Display: **0000**,  blinks.
2. Set key number 1999 [9].
3. Confirm key number ; :
Display: **0000**
4. Return the rotary switch to normal switch position  (information level).

Note:

- The extended information level is deactivated when the key number 1999 is re-ent-ered.
- The key number 1999 cannot be used to change the controller configuration and parameterization. A separate key number exists for configuration and parameterization. Refer to section 2.







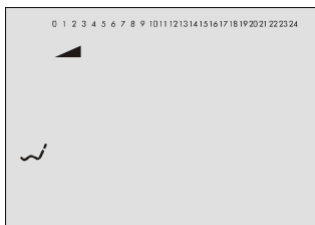

1.8.1 Setting public holidays



On public holidays, the times-of-use specified for Sunday apply. A maximum of 20 public holidays may be entered.

Parameter	WE	Level / Range of values	
Public holidays	–	Extended information level/	01.01 to 31.12

Proceed as follows:





1. In the extended information level (normal switch position ) select data point for public holidays [].
Display: 
2. Open data point for public holidays.
3. If applicable, select .
4. Activate editing mode for public holiday  [].  and blink.
5. Select public holiday [].
6. Confirm public holiday .

To enter additional public holidays, re-select  .  and repeat the steps 4 to 6.

Note: Public holidays can also be set in PA5 parameter level (→ section 2.2).

Deleting a public holiday:

1. Under data point for public holidays, select the holiday you wish to delete [].
2. Confirm selection .

3. Select --- [9].
4. Confirm selection \rightarrow].
The public holiday is deleted.

Note: Public holidays that are not assigned to a specific date should be deleted by the end of the year so that they are not carried on into the following year.

1.8.2 Setting vacation periods







During vacation periods, the controller constantly remains in reduced operation. A maximum of 10 vacation periods can be entered.

Parameter	WE	Level / Range of values
Vacation period	(START, STOP) -	Extended information level / 01.01 to 31.12

Proceed as follows:







1. In the extended information level (normal switch position \rightarrow) select data point for vacation periods [9].
Display: \uparrow
2. Open data point for vacation periods \rightarrow]. Display: **START**
3. If applicable, select --- [9].

4. Activate editing mode for start date of vacation period [].
 and  blink.
5. Edit start date of vacation period [].
6. Confirm start date of the vacation period. Display: **STOP**, **-- --**
7. Edit end of vacation period [].
8. Confirm end of vacation period [].
 The black square at the top of the display indicate the assignment of the vacation periods to the individual control circuits.
9. Select the control circuit to which the current vacation period should apply [].
 - Current vacation period applies to heating circuit 1

To enter additional vacation periods, re-select **-- --** and repeat the steps 4 to 9.

Note: Vacation periods can also be set in PA5 parameter level (-> section 2.2).

Deleting vacation periods:

1. Under data point for vacation periods, select the start date of the period you wish to delete [].
2. Confirm selection :
3. Select **-- --** [].
4. Confirm selection .
 The vacation period is deleted.

Note: Vacation periods should be deleted by the end of the year so that they are not carried on into the following year.

1.9 Entering day and night set points

The desired room temperature for the day (*Day set point*) and a reduced room temperature for the night (*Night set point*) can be entered in the controller for the heating circuit.



Switch position



Parameters		WE	Range of values
Day set point	Rk1	20 °C	0 to 40 °C
DHW temperature set point		55 °C	Min. to max. DHW temperature

Switch position

Parameters		WE	Range of values
Night set point	Rk1	15 °C	0 to 40 °C
DHW sustained temperature		40 °C	Min. to max. DHW temperature

Proceed as follows:

- Turn the rotary switch to the required data point:
 -  for Day set point or DHW temperature set point
 -  for Night set point or DHW sustained temperature

 blinks.
Display: current set point
- Adjust set point [].
- Return the rotary switch to normal switch position  (information level).

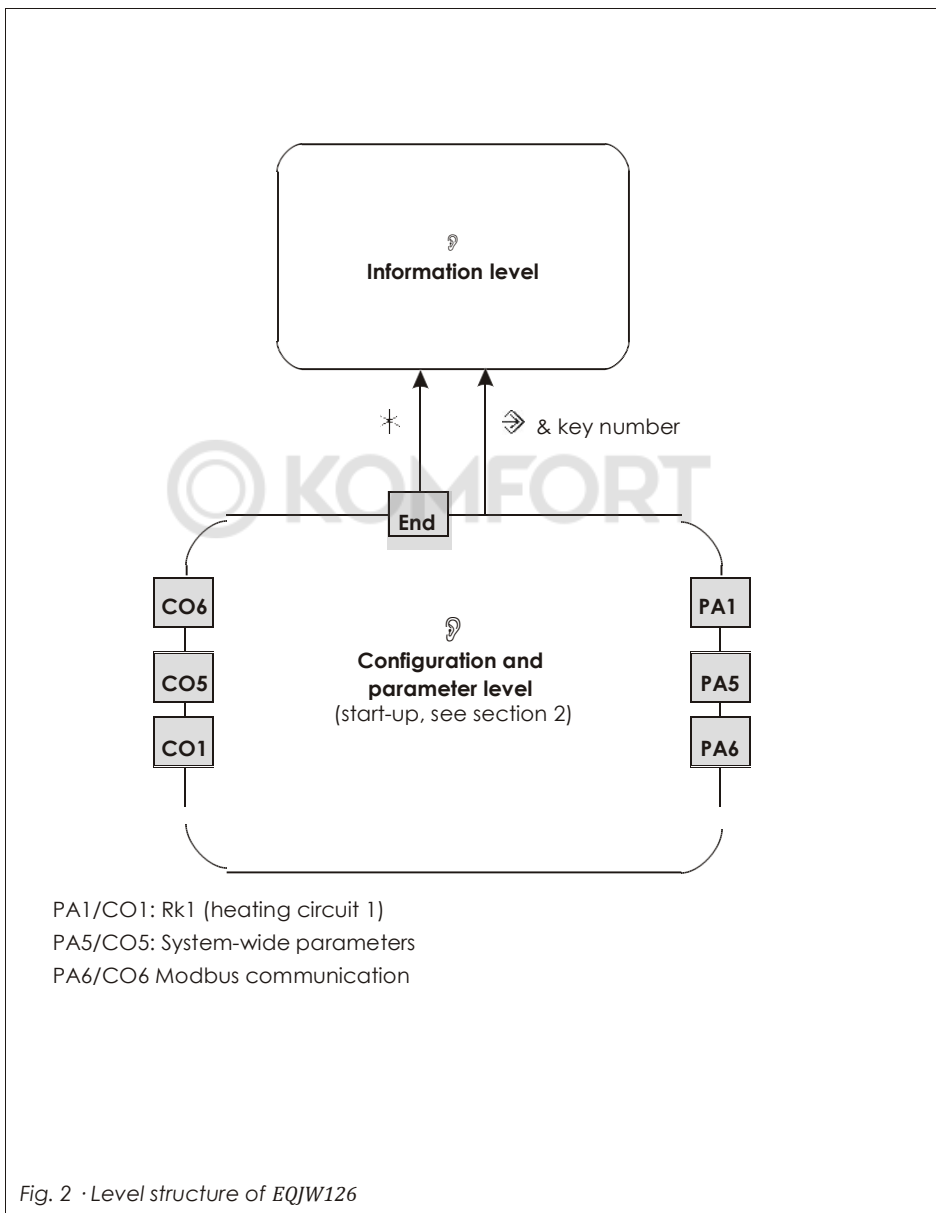

2 Start-up







The modifications of the controller configuration and parameter settings described in this section can only be performed after the valid key number has been entered.

The valid key number for initial start-up can be found on page 86. To avoid unauthorized use of the key number, remove the page or make the key number unreadable. In addition, it is possible to enter a new, customized key number (→ section 7.15).





2.1 Activating and deactivating functions





A function is activated or deactivated in the associated function block. The numbers 0 to 24 in the top row of the display represent the respective function block numbers. When a configuration level is opened, the activated function blocks are indicated by a black square on the right-hand side below the function block number. For more details on function blocks, refer to section 12.1.

The functions are grouped by topics:

-  CO1: Rk1 (Heating circuit 1)
-  CO2: Not applicable
-  CO3: Not applicable
-  CO4: Not applicable
-  CO5: System-wide functions
-  CO6: Modbus communication





Proceed as follows:

1. Turn the rotary switch to  (configuration and parameter level). Set valid key number [].
3. Confirm key number :
Display: **PA_**
4. Select configuration level [].
5. Open configuration level .



6. Select function block [].
Activated function blocks are marked by “- 1”.
Deactivated function blocks are marked by “- 0”.
7. Activate editing mode for the function block  []. blinks.
8. Activate the function block []. Display: **F - 1**
An activated function block is indicated by a black square below (right) the function block number in the top row of the controller display.

or:

Deactivate the function block [].
Display: **F - 0**







10. Confirm settings [].
If the function block is not closed, further function block parameters can be adjusted.
Proceed as follows: 
 - a) Select function block parameter [].
 - b) Confirm function block parameter [].
If applicable, the next function block parameter is displayed.
Confirm all parameters to exit the opened function block.











To adjust additional function blocks in the open configuration level, repeat the steps 6 to 10.

11. Select **End** [].
12. Exit configuration level [].
To adjust additional function blocks in the other configuration levels, repeat 4 to 10.
13. Return the rotary switch to normal switch position  (information level).



2.2 Changing parameters

Depending on the set system code number and the activated functions, not all parameters listed in the parameter list in the Appendix (→ section 12.2) might be available. The parameters are grouped by topics:

-  PA1: Rk1 (Heating circuit 1)
-  PA2: Not applicable
-  PA3: Not applicable
-  PA4: Not applicable
-  PA5: System-wide parameters
-  PA6: Communication parameters

1. Turn the rotary switch to  (configuration and parameter level). Display: **0 0 0 0**
2. Set valid key number [].
3. Confirm key number :
Display: **PA_**
4. Select parameter level [].
5. Open parameter level .
6. Select parameter [].
7. Activate editing mode for the parameter  . blinks.
8. Edit the parameter [].
9. Confirm the parameter  [].

To adjust additional parameters in the open parameter level, repeat steps 6 to 9.

10. Select **End** [].
 11. Exit parameter level .
- To adjust additional parameters in another parameter level, repeat steps 4 to 9.
12. Return the rotary switch to normal switch position  (information level).

2.3 Calibrating sensors

The controller is designed for the connection of Pt 1000 sensors.

The resistance values of the Pt 1000 sensors can be found on page 75.

If the temperature values displayed at the controller differ from the actual temperatures, the measured values of all connected sensors can be readjusted. To calibrate a sensor, the currently displayed sensor value must be changed such that it matches the temperature (reference temperature) measured directly at the point of measurement.

Sensor calibration is to be activated in CO5 via function block F20. An incorrect sensor calibration can be deleted by setting F20 - 0.

Proceed as follows:

1. Turn the rotary switch to (configuration and parameter level). Display: **0000**.
2. Set valid key number [**9**].
3. Confirm valid key number [*]. Display: **PA_**.
4. Select CO5 configuration level [**9**].
5. Open CO5 configuration level [*].
6. Select function block F20 [**9**].
7. Activate editing mode for function block F20 [*].
8. Select appropriate sensor icon [**9**]:



Room sensor RF, heating circuits



Outdoor sensor AF



Flow sensor VF, heating circuits



Return flow sensor RÜF



9. Display measured value [*]. "°C" blinks.
10. Correct measured value [**9**].
Read the actual temperature directly from the thermometer at the point of measurement and enter this value as the reference temperature.
11. Confirm corrected measured value [*].

Additional sensors are calibrated similarly.

12. Select **End** [].
13. Return the rotary switch to normal switch position  (information level).

2.4 Resetting to default values

All parameters set over the rotary switch as well as parameters in PA1, PA2 and PA5 parameter levels can be reset to their default settings (WE), except for the maximum flow temperature and the return flow temperature limits in PA1 and PA2.

1. Turn the rotary switch to  (configuration and parameter level). Display: **0000**
2. Set key number 1991 [].
3. Confirm key number ].
The controller is reset to its default settings.
Display: **0000**







3 Manual operation

Switch to manual mode to configure all outputs, refer to wiring diagram (-> section 11).

NOTICE

The frost protection does not function when the controller is in manual mode.

Proceed as follows:

1. Turn the rotary switch to  (manual level).
2. Select output depending on the control circuit
 (): POS_ Positioning value in percent
 UP_ Activation/deactivation of the circulation pump (heating)
3. Confirm the output :
]. The display blinks.
4. Change positioning value/switching state [].
5. Confirm setting .
 The modified values remain active as long as the controller is in manual mode.
6. Return the rotary switch to normal switch position  (information level). The manual mode is deactivated.

Note: *The outputs of the controller are not affected by simply turning the rotary switch to  (manual level). You have to actually enter a positioning value or activate/deactivate the pumps to configure the outputs*

4 Hydraulic system

This is the hydraulic schematic for the controller. The energy source can also be a boiler, then the boiler is controlled by an on/off output (CO1 -> F12-0).

System Anl 1.0

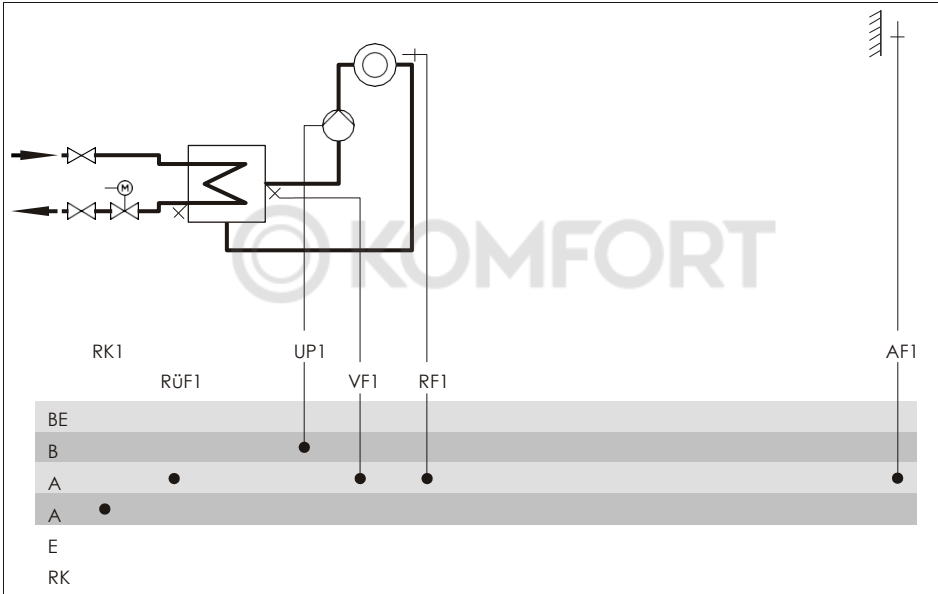

Default settings

CO1 -> F01	- 0 (without RF)
CO1 -> F02	- 1 (with AF)
CO1 -> F03	- 1 (with RÜF)



© KOMFORT

5 Functions of the heating circuit

5.1 Weather-compensated control

When weather-compensated control is used, the flow temperature is controlled according to the outdoor temperature. The heating characteristic in the controller defines the flow temperature set point as a function of the outdoor temperature (→ Fig. 3). The outdoor temperature required for weather-compensated control is measured by an outdoor sensor.

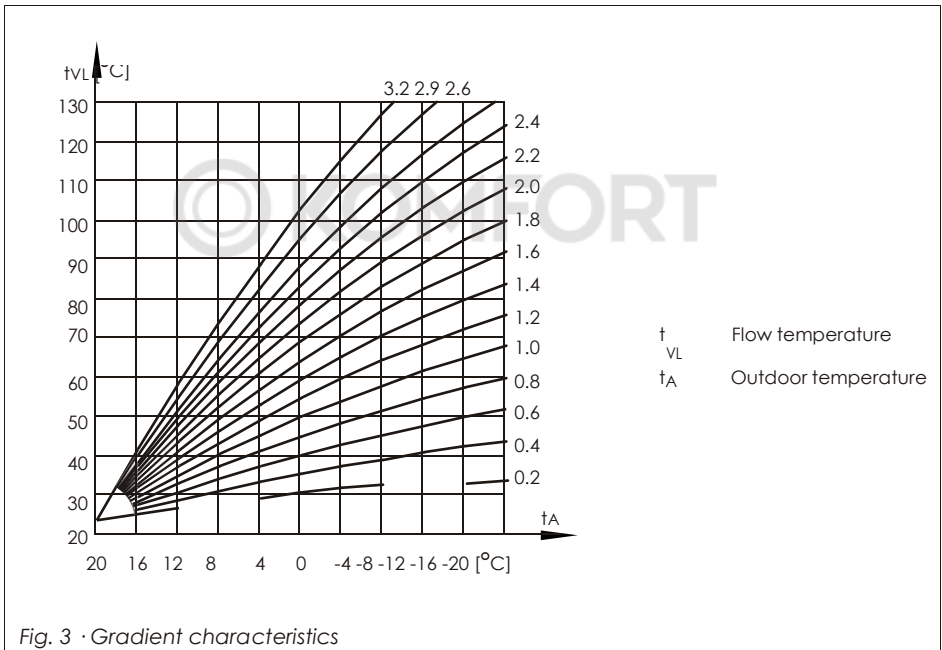

Fig. 3 · Gradient characteristics

Function	WE	Configuration
Outdoor sensor AF	1	CO1 -> F02 - 1

5.1.1 Gradient characteristic

Basically, the following rule applies: a decrease in the outdoor temperature causes the flow temperature to increase in order to keep the room temperature constant.

By varying the parameters *Gradient* and *Level*, you can adapt the characteristic to your individual requirements:

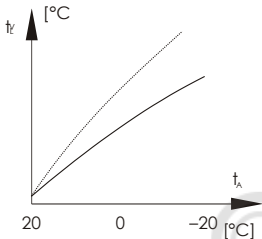

The gradient needs to be increased **if the room temperature drops when it is cold outside.**

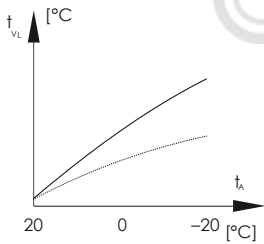

The gradient needs to be decreased **if the room temperature rises when it is cold outside.**

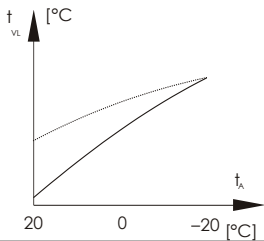

The level needs to be increased and the gradient decreased **if the room temperature drops when it is mild outside.**

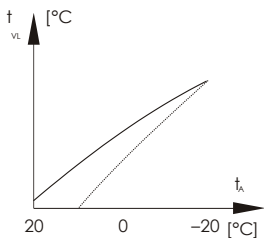

The level needs to be decreased and the gradient increased **if the room temperature rises when it is mild outside.**

Outside the times-of-use, reduced set points are used for control:

The reduced flow set point is calculated as the difference between the adjusted values for *Day set point* (rated room temperature) and *Night set point* (reduced room temperature).

The *Max. flow temperature* and *Min. flow temperature* parameters mark the upper and lower limits of the flow temperature. A separate gradient characteristic can be selected for the limitation of the return flow temperature.

Examples for adjusting the characteristic:

- ☺☺ Oldbuilding, radiator design 90/70: Gradient approx. 1.8
- ☺☺ Newbuilding, radiator design 70/55: Gradient approx. 1.4
- ☺☺ Newbuilding, radiator design 55/45: Gradient approx. 1.0
- ☺☺ Underfloor heating depending on arrangement: Gradient smaller than

0.5

Note: Particularly for control operation without room sensor, the room temperatures set for day (*Day set point*) and night (*Night set point*) only become effective satisfactorily when the heating characteristic has been adapted to the building/heating surface layout.

Function	WE	Configuration
Four-point characteristic	0	CO1 -> F11 - 0
Parameters	WE	Switch position / Range of values
Day set point	20.0 °C	↓☼ / 0.0 to 40.0 °C
Night set point	15.0 °C	/ 0.0 to 40.0 °C
Parameters	WE	Parameter level / Range of values
Gradient, flow	1.8*	PA1 / 0.2 to 3.2
Level, flow	0.0 °C	PA1 / -30.0 to 30.0 °C
Min. flow temperature	20.0 °C	PA1 / 5.0 to 130.0 °C
Max. flow temperature	90.0 °C*	PA1 / 5.0 to 130.0 °C
* With CO1 -> F05 - 1, the following applies: Gradient, flow / 0.2 to 1.0 (1.0) Max. flow temperature / 5.0 to 50.0 °C (50.0 °C)		

5.1.2 Four-point characteristic

The four-point characteristic allows you to define your own heating characteristic. It is defined by four points for the outdoor temperature, flow temperature, reduced flow temperature and return flow temperature. The 'Max. flow temperature' and 'Min. flow temperature' parameters mark the upper and lower limits of the flow temperature.

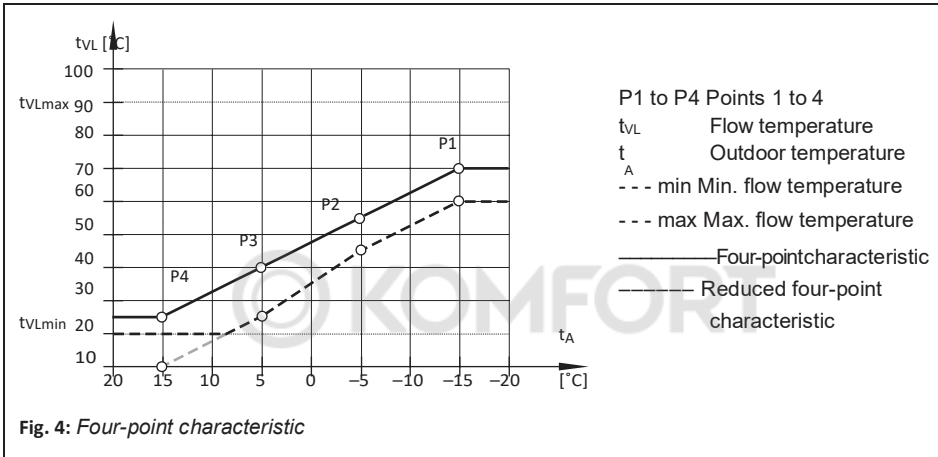

Fig. 4: Four-point characteristic



Note:

- The 'Day set point' and 'Night set point' parameters are no longer available when the four-point characteristic has been selected, provided no additional functions (e.g. optimization, flash adaptation) have been selected.
- The four-point characteristic function can only be activated when the adaptation function is not active (CO1, 2 > F08 - 0).

Functions	WE	Configuration
Adaptation	0	CO1, 2 > F08 - 0
Four-point characteristic	0	CO1, 2 > F11 - 1
Parameters	WE	Parameters: value range
Outdoor temperature	Point 1	-15.0 °C
	Point 2	-5.0 °C
	Point 3	5.0 °C
	Point 4	15.0 °C

Parameters		WE	Parameter level / Range	of values
Flow temperature	Point 1	70.0 °C	PA1 / 5.0 to 130.0 °C	
	Point 2	55.0 °C		
	Point 3	40.0 °C		
	Point 4	25.0 °C		
Reduced flow temperature	Point 1	60.0 °C	PA1 / 5.0 to 130.0 °C	
	Point 2	40.0 °C		
	Point 3	20.0 °C		
	Point 4	20.0 °C		
Return flow temperature	Points 1 to 4	65.0 °C	PA1 / 5.0 to 90.0 °C	
Min. flow temperature		20.0 °C	PA1 / 5.0 to 130.0 °C	
Max. flow temperature		90.0 °C*	PA1 / 5.0 to 130.0 °C	

* With CO1 -> F05 - 1, the following applies: Max. flow temperature / 5 to 50 °C (50 °C)

5.2 Fixed set point control

During the times-of-use, the flow temperature can be controlled according to a fixed set point. Outside the times-of-use, the controller regulates to a reduced flow temperature.

Set the desired rated flow temperature as *Day set point*, and the reduced flow temperature as *Night set point*.

Functions	WE	Configuration
Outdoor sensor AF	1	CO1 -> F02 - 0
Parameters	WE	Switch position / Range of values
Day set point	50.0 °C	↓☼ / Min. to max. flow temperature
Night set point	30.0 °C	☾ / Min. to max. flow temperature
Parameters	WE	Parameter level / Range of values
Min. flow temperature	20.0 °C	PA1 / 5.0 to 130.0 °C
Max. flow temperature	90.0 °C	PA1 / 5.0 to 130.0 °C

5.3 Underfloor heating/drying of jointless floors

Using function block setting CO1 -> F05 - 1, the respective heating circuit is configured as an underfloor heating circuit. In doing so, the controller at first only

limits the value



ranges of the heating characteristic gradient and the maximum flow temperature in PA1 parameter level:

 Value range of the gradient: 0.2 to 1.0

 Value range of the maximum flow temperature: 5 to 50 °C

In addition, it is possible to activate the **Drying of jointless floors** function. In connection with this, the function block parameters are listed which appear after activating this function block. They determine the drying process: the first heating up phase starts at the entered *Start temperature*, which has a flow temperature of 25 °C in its default setting. In the course of 24 hours, this temperature is raised by the value entered in *Temperature rise*, i.e. the default setting causes the flow temperature set point to rise to 30

°C. If the *Maximum temperature* is reached, it is kept constant for the number of days entered in *Maintaining time for maximum temperature*. The *Temperature reduction* determines the temperature reduction downwards. If the *Temperature reduction* is set to 0, the temperature maintaining phase moves directly to automatic mode. The drying of jointless floor runs to comply with DIN EN 1264 Part 4 when *Start temperature* is set to 25 °C and *Temperature rise per day* to 0.0 °C. As a result, the function starts with a flow temperature of 25 °C regulated to be kept constant for three days. Following this, the temperature is increased to the maximum adjusted temperature. The further process continues as described.

The drying function is activated by changing the setting STOP to START *temperature build-up phase* (. **STArT** on the display). The restarting stages *START temperature main- taining phase* (. **STArT** on the display) and *START temperature reduction phase* (. **STArT** on the display) can be selected to continue an interrupted drying process. The course of the drying process can be monitored in the information level over the icon of flow tem- perature display () of the associated heating circuit:

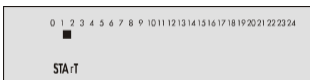

Temperature build-up phase

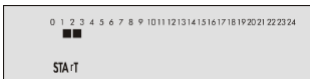

Temperature maintaining phase

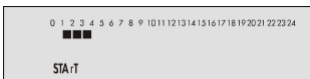

Temperature reduction phase

The drying process has been successfully completed when the additional icon in the flow temperature display goes out after the last phase.

STOP on the display indicates that there has been a deviation of flow temperature of more than 5 °C for longer than 30 minutes. The function is canceled by the controller in such cases. While STOP appears on the display, the controller keeps the flow temperature constant at 25 °C.

A power failure while the drying function is active or when STOP appears on the display automatically leads to the drying function restarting from the beginning.

NOTICE

The function block parameter can only be accessed when the function has started by de-activating the function block and activating it again.

Functions	WE	Configuration
Underfloor heating	0	CO1 -> F05 - 1
Drying of jointless floors	25 °C	Start temperature / 20 to 60 °C
	5.0 °C	Temperature rise per day / 0.0 to 10.0 °C
	45.0 °C	Maximum temperature / 25.0 to 60.0 °C
	4	Maintaining time for max. temperature / 0 to 10 days
	0.0 °C	Temperature reduction per day / 0.0 to 10.0 °C
	SToP	. STArT, .STArT, .STArT

5.4 Deactivation depending on outdoor temperature

5.4.1 OT deactivation value in rated operation

If the outdoor temperature exceeds the limit *OT deactivation value in rated operation*, the affected heating circuit is put out of service immediately. The valve is closed and the pump is switched off after $t = 2 \times$ valve transit time. When the outdoor temperature falls below this value (less 0.5 °C hysteresis), heating operation is restarted immediately.

With the default settings, this means that, during the warm season, the system is switched off at an outdoor temperature of 22 °C.

Parameter	WE	Parameter level / Range	of values
OT deactivation value in rated operation	22.0 °C	PA1 / 0.0 to 50.0 °C	

5.4.2 OT deactivation value in reduced operation

If the outdoor temperature exceeds the limit value *OT deactivation value in reduced operation* in reduced operation, the affected heating circuit is put out of service immediately.

The valve is closed and the pump is switched off after $t = 2 \times$ valve transit time. When the outdoor temperature falls below this value (less 0.5 °C hysteresis), heating operation is restarted immediately.

With the default settings, this means that, at night, the system is switched off at an outdoor temperature of 15 °C to save energy. Nevertheless, remember that the system requires some time in the morning to heat up the building.

Parameter	WE	Parameter level / Range	of values
OT deactivation value in reduced operation	15.0 °C	PA1 / -20.0 to 50.0 °C	

5.4.3 OT activation value in rated operation

If a heating circuit is in reduced operation (automatic mode), the circuit is automatically transferred to rated operation when the outdoor temperature falls below the limit value *OT activation value in rated operation*. When the limit value is exceeded (plus 0.5 °C hysteresis), reduced operation is restarted.

This function is activated at very low temperatures to avoid that the building cools down excessively outside the times-of-use when low outdoor temperatures occur.

Parameter	WE	Parameter level / Range	of values
OT activation value in rated operation	-15.0 °C	PA1 / -20.0 to 5.0 °C	

5.4.4 Summer mode

Summer mode is activated depending on the mean daytime temperature (measured between 7.00h and 22.00h) during the desired period.

If the mean daytime temperature exceeds the *OT limit value in summer mode* on n successive days, summer mode is activated on the following day. This means that the valves in all heating circuits are closed and the circulation pumps are switched off after $t = 2 \times$ valve transit time. If the mean daytime temperature remains below the *OT limit value in summer mode* on m successive days, summer mode is deactivated on the following day.



Function	WE	Configuration
Summer mode	0	CO5 -> F04 - 1
	01.06	Start summer mode/ 01.01 (1 Jan) to 31.12(31 Dec)
	2	Dec)
	30.09	No. of days until activation / 1 to 3
	1	Stop summer mode / 01.01 to 31.12
	18.0 °C	No. of days until deactivation / 1 to 3 OT limit value summer mode / 0 to 30 °C

Note: Summer mode only becomes effective when the controller is in automatic mode (☺).

5.5 Delayed outdoor temperature adaptation

The calculated outdoor temperature is used to determine the flow temperature set point. The heat response is delayed when the outdoor temperature either decreases, increases or increases and decreases. If the outdoor temperature varies by, for example, 12 °C within a very short period of time, the calculated outdoor temperature is adapted to the actual outdoor temperature in small steps. Assuming a Delay of 3°C/h, the adaptation would take $t = \frac{12^{\circ}\text{C}}{3^{\circ}\text{C/h}} = 4\text{h}$.

Note:

The delayed outdoor temperature adaptation helps avoid unnecessary overloads of central heating stations in combination with either overheated buildings occurring, for example, due to warm winds, or temporarily insufficient heating due to the outdoor sensor being exposed to direct sunshine.



In the information level, the outdoor temperature blinks on the display while delayed outdoor temperature adaptation is active. The calculated outdoor temperature is displayed.

Functions	WE	Configuration
Delayed OT adaptation when OT decreases	0	CO5 -> F05 - 1
Delayed OT adaptation when OT increases	0	CO5 -> F06 - 1
3.0 °C Delay per hour / 1.0 to 6.0 °C		

5.6 Optimization

This function requires the use of a room sensor. Depending on the building characteristics, the controller determines and adapts the required advance heating time (maximum 8 hours) to ensure that the desired *Day set point* (rated room temperature) has been reached in the reference room when the time-of-use starts. During the advance heating period, the controller heats with the max. flow temperature. This temperature is built up in steps of 10 °C. As soon as the *Day set point* has been reached, weather-compensated control is activated.



Depending on the room sensors, the controller switches off the heating system up to one hour before the time-of-use ends. The controller chooses the deactivation time such that the room temperature does not drop significantly below the desired value until the time-of-use ends.

During the advance heating period and the premature deactivation of the heating system, the icons  or  blink on the display. Outside the times-of-use, the controller monitors the *Night set point* (reduced room temperature). When the temperature falls below the night set point, the controller heats with the max. flow temperature until the measured room temperature exceeds the adjusted value by 1 °C.

Note:

Direct sunshine can cause the room temperature to increase and thus result in the premature deactivation of the heating system.

When the room temperature decreases while the heating system is shortly outside its times-of-use, this can prematurely cause the controller to heat up to the Day set point.

Functions	WE	Configuration
Room sensors RF	0	CO1 -> F01 - 1
Outdoor sensor AF	1	CO1 -> F02 - 1
Optimization	0	CO1 -> F07 - 1
Parameters	WE	Switch position / Range of values
Day set point	20.0 °C	  / 0.0 to 40.0 °C
Night set point	15.0 °C	/ 0.0 to 40.0 °C

5.7 Flash adaptation

To ensure that the controller reacts immediately to room temperature deviations during rated or reduced operation, the function block setting CO1, 2 -> F09 - 1 needs to be made.

The heating is then always switched off as soon as the room temperature exceeds the

Day set point or *Night set point* by 2 °C.

Heating first starts again when the room has cooled off and the room temperature is 1

°C above the *Set point*. The flow temperature set point is corrected if the *Cycle time* and *Gain K* are set to a value other than 0. The *Cycle time* determines the intervals at which the flow temperature set point is corrected by 1 °C. A *Gain K* set to a value other than 0 causes a direct increase/decrease in flow temperature set point when a sudden deviation in room temperature arises. A *Gain K* setting of

10.0 is recommended.

Note:

Cooling loads, such as drafts or open windows, affect the control process! Rooms may be temporarily overheated after the cooling load has been

eliminated!

Functions	WE	Configuration
Room sensors RF	0	CO1 -> F01 - 1
Flash adaptation	0	CO1 -> F09 - 1
	20 min	Cycle time / 0 to 100 min
	0.0	KP (gain) / 0.0 to 25.0
Parameters	WE	Switch position / Range of values
Day set point	20.0 °C	 / 0.0 to 40.0 °C
Night set point	15.0 °C	/ 0.0 to 40.0 °C

5.7.1 Flash adaptation without outdoor sensor

The flow temperature control starts with *Day set point for flow* in rated operation or with *Night set point for flow* in reduced operation as no set points calculated using characteristics exist without an outdoor sensor. The *Cycle time* determines the intervals at which the flow temperature set point is corrected by 1 °C. The heating is then always switched off as soon as the room temperature exceeds the *Day set point* or *Night set point* by 2 °C. Heating first starts again when the room has cooled off and the room temperature is 1

°C above the *Set point*. A *Gain K* set to a value other than 0 causes a direct increase/de-



crease in flow temperature set point when a sudden deviation in room temperature arises. A *Gain K* setting of 10.0 is recommended.

Functions	WE	Configuration
Room sensors RF	0	CO1 -> F01 - 1
Outdoor sensors AF	1	CO1 -> F02 - 0
Flash adaptation	0	CO1 -> F09 - 1
	20 min	Cycle time / 1 to 100 min
	0.0	KP (gain) / 0.0 to 25.0
Parameters	WE	Switch position / Range of values
Day set point	20.0 °C	☀ / 0.0 to 40.0 °C
Night set point	15.0 °C	☾ / 0.0 to 40.0 °C

Parameters	WE	Parameter level / Range	of values
Day set point for flow	50.0 °C	PA1	/ 5.0 to 130.0 °C
Night set point for flow	30.0 °C	PA1	/ 5.0 to 130.0 °C

5.8 Adaptation

The controller is capable of automatically adapting the heating characteristic to the building characteristics, provided a gradient characteristic has been set (CO1 -> F11 - 0). The reference room, where the room sensor is located, represents the entire building and is monitored to ensure that the room set point (*Day set point*) is maintained. When the mean measured room temperature in rated operation deviates from the adjusted set point, the heating characteristic is modified accordingly for the following time-of-use. The corrected value is displayed in PA1 parameter levels under *Gradient, flow*.

Functions	WE	Configuration
Room sensors RF	0	CO1 -> F01 - 1
Outdoor sensors AF	1	CO1 -> F02 - 1
Adaptation	0	CO1 -> F08 - 1
Four-point characteristic	0	CO1 -> F11 - 0
Parameters	WE	Switch position / Range of values
Day set point	20.0 °C	☀ / 0.0 to 40.0 °C
Night set point	15.0 °C	☾ / 0.0 to 40.0 °C

Note: If the **Flash adaptation** function is already configured with a small cycle time, the **Adaptation** function should not be configured as well.

5.9 Cooling control

Cooling control with outdoor sensor

When the cooling control function is activated in a control circuit, the four-point characteristic of the corresponding control circuit is automatically activated and the operating direction of the control output is reversed. In PA1 the four points for the course of the set point based on the outdoor temperatures can be adjusted separately for day and night mode. The *Base point for return flow temperature* that can be adjusted with an active return flow sensor determines the point at which a minimum limitation of the return flow temperature starts: If the measured return flow temperature falls below this value, the flow temperature set point is raised. The four return flow temperature values in the four-point characteristic function have no effect.

Functions		WE	Configuration
Cooling control		0	CO1 -> F04 - 1
Four-point characteristic		0	CO1 -> F11 - 1
Parameters		WE	Parameter level / Range of values
Outdoor temperature	Point 1	-15 °C	PA1 / -40 to 50 °C
	Point 2	-5 °C	
	Point 3	5 °C	
	Point 4	15 °C	
Flow temperature	Point 1	70 °C	PA1 / 5 to 130 °C
	Point 2	55 °C	
	Point 3	40 °C	
	Point 4	25 °C	
Reduced flow temperature	Point 1	60 °C	PA1 / 5 to 130 °C
	Point 2	40 °C	
	Point 3	20 °C	
	Point 4	20 °C	
Base point of return flow temperature		65 °C	PA1 / 5 to 90 °C

Note: The limiting factors of the **Return flow sensor RÜF (CO1 -> F03) functions apply during cooling control as well.**



Cooling control without outdoor sensor

When the cooling control function is activated in a control circuit without outdoor sensor, only the adjustment limits for the day and night set points at the rotary switch as well as the *Base point for return flow temperature* can be adjusted in PA1 and/or PA2.

Functions	WE	Configuration
Outdoor sensor AF		CO1 -> F04 - 0
Cooling control	0	CO1 -> F04 - 1
Parameters	WE	Rotary switch / Range of values
Day set point	20.0 °C	☀ / 0.0 to 40.0 °C
Night set point	15.0 °C	☾ / 0.0 to 40.0 °C
Parameters	WE	Parameter level / Range of values
Min. flow temperature	20 °C	PA1 / 5.0 to 130.0 °C
Max. flow temperature	90 °C	PA1 / 5.0 to 130.0 °C
Base point of return flow temperature	65 °C	PA1 / 5.0 to 90.0 °C

6 System-wide functions



6.1 Automatic summer time/winter time changeover

The clock is automatically adjusted on the last Sunday in March at 2.00h and on the last Sunday in October at 3.00h.

Function	WE	Configuration
Summer time/winter time changeover	1	CO5 -> F08 - 1

6.2 Frost protection

Frost protection measures are taken when the outdoor temperature falls below the *Frost protection limit*. The switching differential to cancel the frost protection measures is always 1 °C.

-  Frost protection program I (restricted frost protection): frost protection measures are taken only when all heating circuits in the system are in stand-by mode.
-  Frost protection program II: the heating circuit circulation pumps are always switched on automatically. The flow temperature set points of all heating circuits currently in stand-by mode are set to +10 °C.

Functions	WE	Configuration
Frost protection program I	1	CO5 -> F09 - 0
Frost protection program II	3.0 °C	Frost protection limit / -15.0 to 3.0 °C
Frost protection program I	1	CO5 -> F09 - 1
Frost protection program II	3.0 °C	Frost protection limit / -15.0 to 3.0 °C

NOTICE

Frost protection operation of a pump is only active when the frost protection icon  appears on the display.

In the stand-by mode  fixed set point control without outdoor temperature sensor does not include frost protection.

6.3 Forced operation of the pumps

When the heating circuit pump has not been activated for 24 hours, forced

operation of the pump is started between 12.02h and 12.03h. This is done to avoid that the pump get stuck when it is not operated for a longer period of time.



© KOMFORT

6.4 Return flow temperature limitation

The temperature difference between the flow and return flow indicates how well the energy is used: the greater the difference, the higher the efficiency. A return flow sensor is sufficient to evaluate the temperature difference when the flow temperatures are pre-set. The return flow temperature can be limited either to a value depending on the outdoor temperature (variable) or to a fixed set point. When the temperature measured at return flow sensor RÜF exceeds the limit value, the set point of the flow temperature (flow temperature of the heating system, charging temperature) is reduced. As a result, the primary flow rate is reduced and the return flow temperature falls.

The *Limiting factor* determines how strongly the controller responds when the limit values are exceeded in either direction (PI algorithm).

If just proportional component is to be implemented, set CO5 -> F16 - 1. This allows the integral-action component in the return flow temperature limitation algorithm of all control circuits of the controller to be deactivated. The set point reading (flow temperature of the heating, charging temperature) blinks to indicate that a return flow limitation is active in the control circuit concerned.

Note: Using weather-compensated control with gradient characteristic, the return flow temperature is limited to a fixed value by equating the Base point of return flow temperature and Max. return flow temperature (PA1) parameters.

Functions	WE	Configuration
Return flow sensors RÜF1	1	CO1, 2, 4 -> F03 - 1
	1.0	KP (limiting factor) / 0.1 to 10.0
Return flow temperature limitation with P algorithm*	0	CO5 -> F16
* If CO5 -> F00 - 1 is indicated, access to the return flow, flow rate and heat capacity settings are locked.		

Parameters	WE	Parameter level / Range	of values
Gradient, return flow	1.2	PA1 / 0.2 to 3.2	
Level, return flow	0.0 °C	PA1 / -30.0 to 30.0 °C	
Base point of return flow temperature	65.0 °C	PA1 / 5.0 to 90.0 °C	
Max. return flow temperature	65.0 °C	PA1, 4 / 5.0 to 90.0 °C	

or

Parameter	WE	Parameter level / Range	of values
Return flow temp. points	1 to 4	65.0 °C PA1 / 5.0 to 90.0 °C	

NOTICE

To ensure that the preset return flow temperature limit can be met, make sure that

- the heating characteristic is not adjusted to ascend too steeply,
- the speed of the circulation pumps is not set too high,
- the heating systems have been calibrated.

6.5 Condensate accumulation control

Activate the **Limit deviation for OPEN signal** function to start up condensate accumulation plants, in particular to avoid problematic excess temperatures. The controller response to set point deviations which cause the primary valve to open is attenuated. The controller response to set point deviations which cause the control valve to close remains unaffected.

Note: The condensate accumulation control function can only be activated when the control circuit concerned is controlled using a PI algorithm (three-step control).

Functions	WE	Configuration
Control mode	1	CO1, 2, 4 -> F12 - 1
Limit deviation for OPEN signal	0	CO1, 2, 4 -> F13 - 1
	2.0 °C	Max. deviation / 2.0 to 10.0 °C

6.6 Three-step control

The flow temperature can be controlled using a PI algorithm. The valve reacts to pulses that the controller sends when a system deviation occurs. The length of the first pulse, in particular, depends on the extent of the system deviation and the selected *Proportional gain K* (the pulse length increases as *K* increases). The pulse and pause lengths change continuously until the system deviation has been eliminated. The pause length between the single pulses is greatly influenced by the *Reset time T* (the pause length increases as *T* increases).

The *Transit time T* specifies the time required by the valve to travel through the range of 0 to 100 %.

Function	WE	Configuration
Control mode	1	CO1, 2, 4 -> F12 - 1, Rk_
	2.0	KP (proportional gain) / 0.1 to
	50.0	120 s Tn (reset time) / 1 to 999 s
	0 s	TV (derivative-action time) / Do not change!
	45 s	TY (valve transit time) / 5, 10, 15, ... , 240s

6.7 On/off control

The flow temperature can be controlled, for example, by activating and deactivating a boiler. The controller switches on the boiler when the flow temperature falls below the set point by $T = 0.5 \times \text{hysteresis}$. When the set point is exceeded by $T = 0.5 \times \text{hysteresis}$, the boiler is switched off again. The greater the value you choose for *Hysteresis*, the lower the activation/deactivation frequency will be. By setting the *Minimum ON time*, an activated boiler remains switched on during this period regardless of the flow temperature fluctuations. Similarly, a deactivated boiler will remain switched off regardless of the flow temperature fluctuations if the *Min. OFF time* has been specified.

Function	WE	Configuration
Control mode	1	CO1, 2, 4 -> F12 - 0
	5.0 °C	Hysteresis / 1.0 to 30.0 °C
	2 min	Min. ON time / 0 to 10 min
	2 min	Min. OFF time / 0 to 10 min

6.9 Locking manual level

To protect the heating system, this function can be used to lock the manual level. When this function has been activated, automatic mode is started when the rotary switch is set to  automatic mode.

Function	WE	Configuration
Locking manual level	0	CO5 -> F21 - 1



6.10 Locking the rotary switch

When this function has been activated, the controller remains in automatic mode regardless of the rotary switch position. The rotary switch can no longer be used to adjust the controller settings. It is still possible to enter the key number.

Function	WE	Configuration
Locking the rotary switch	0	CO5 -> F22 - 1

6.11 Setting a customized key number

To avoid the unauthorized modification of functions and parameters of the controller, the default key number can be replaced with an individual key number.

Choose your custom key number between 0100 and 1900.

Proceed as follows:

1. Turn the rotary switch to **4** (configuration and parameter level). Display: **0 0 0 0**
2. Set key number 1995 [**9**].
3. Confirm key number **↵**.
4. Enter valid key number [**9**].
5. Confirm key number **↵**:
Key number blinks.
6. Adjust desired custom key number [**9**].
7. Confirm custom key number **↵**:
This new key number is now valid.
8. Return rotary switch to the standard switch position (information level).







7 Operational faults

A sensor malfunction is indicated by the blinking  icon on the display. The "Error" message is displayed immediately. Press the rotary pushbutton to open the error level. It may be possible to view several error messages by turning the rotary pushbutton. As long as an error message is present, the error level is displayed, even though it has not been opened by pressing the rotary pushbutton.

In the error level, the error message is displayed as specified in the list below (section 7.1).



Note: After the system code number has been changed or after restarting the controller, any error messages are suppressed for approx. three minutes.

7.1 Error list

-  Err 1 = Sensor failure (-> section 7.2)
-  Err 2 = Reserved
-  Err 3 = Reserved
-  Err 4 = Reserved
-  Err 5 = Reserved
-  Err 6 = Temperature monitoring alarm (-> section 8.3)
-  Err 7 = Unauthorized access occurred (-> section 8.1)





All error messages, except for "Err 1" can be confirmed in the error level.

When an error message is indicated, proceed as follows:

1. Select *Clr* on the display [].
2. Confirm the error message [].

7.2 Sensor failure

According to the error list, sensor failures are indicated by displaying "Err 1" error message in the error level. For detailed information, exit error level and view the different temperature values in the information level: each sensor icon displayed together with 3 horizontal lines instead of the measured value indicates a defective sensor. The following list explains how the controller responds to the failure of the different sensors.

-  **Outdoor sensor AF:** When the outdoor sensor fails, the controller uses a flow temperature set point of 50 °C or the *Max. flow temperature* when the *Max. flow temperature* (adjusted at PA1) is lower than 50 °C.
-  **Flow sensor in heating circuit:** When the flow sensors in the heating circuits are defective, the associated valve moves to 30 % travel.
-  **Return flow sensors RÜF:** When the return flow sensor fails, the controller continues operation without return flow temperature limitation.
-  **Room sensors RF:** When the room sensor fails, the controller uses the settings for operation without room sensor. The controller, for example, switches from optimizing mode to reduced operation; adaptation mode is canceled. The last determined heating characteristic remains unchanged.

7.3 Temperature monitoring

When a system deviation greater than 10 °C persists in a control circuit for 30 minutes, an "Err 6" error message (temperature monitoring alarm) is generated.

Function	WE	Configuration
Temperature monitoring	0	CO5 -> F19 - 1

7.4 Error status register

The error status register is used to indicate controller or system errors. In modern operation mode when the controller dials the building control system (GLT) both when an error is detected and when it has been corrected, each change in the status of the error status register causes the controller to dial the control system. You can define which error messages are to influence the error status register after entering the key number 0025. The default setting of 465 results in just the error messages highlighted in the table (bold) causing a change in state of the error status register.

46 BA_EQJW126F001_EN001



© KOMFORT

Error message	Meaning	Decimal value		
Err 1	Sensor failure	1	1	1
Err 2	–	2		
Err 3	–	4		
Err 4	–	8		
Err 5	–	16	16	
Err 6	Temperature monitoring alarm	32		32
Err 7	Unauthorized access occurred	64	64	
Err 8	–	128	128	
Err 9	–	256	256	
			Total	Total
Default setting range after entering the key number 0025 =			465	
Example: Value of error status register when a sensor fails and a temperature monitoring alarm=				33

7.5 Sending text messages in case of error

If a dial-up modem is connected to RS-232/modem communications module (-> section 8.1), the controller can send a text message to a mobile phone when an error occurs.

As soon as a fault has been registered in the error status register, the text message indicating a controller fault is sent. On the mobile phone, the following error message is displayed:

[Date	[Time]
[Phone no. of the controller]	
Controller fault	
EQJW126 # [controller ID of the faulty	

The time stamp [Date], [Time] is added by the text messaging center, not by the controller. If an error message is transmitted to the controller equipped with a dial-up modem, the controller ID of the faulty controller is sent, instead of the controller ID of the “modem controller”. A detailed error message is not



available.



Note: The controller ID is indicated in the extended information level at Info 2 listed as the first value in the sequence (-> section 1.8).

When Modbus is activated and, at the same time, the dial-up in case of error is released, the connection with the building control station is established first, and then the text message is sent. If the first attempt to connect to the building control station fails, the controller tries again until the programmed number of redialing attempts has been exhausted.

In Germany, the access numbers (TAPnr) of the SMS service center are currently:

-  **D1** network: 0171 252 1002 (alternatively, 0171 252 1099 is also possible)
-  **E-Plus** network: 0177 1167
-  **Cellnet (UK)** network: 0044 786 098 0480 – routing into the **D1**, **D2** and **E-Plus** networks.

Add "0" to the number when dialing from a telephone extension. The mobile phone number (HAndi) must be entered as follows: 49 xxx yyyyyy, where xxx stands for 160, 171 or any other valid dialing code and yyyyyy represents the specific phone number of the mobile you wish the error message to be sent to.

Functions	WE	Configuration
Text message	0	CO6 -> F08 - 1
Modem function	0	CO6 -> F03 - 1
Automatic modem configuration	0	CO6 -> F04 - 1
Parameters*	WE	Parameter level / Range of values
Modem dialing pause (P)	5 min	PA6 / 0 to 255 min
Modem timeout (T)	5 min	PA6 / 1 to 255 min
No. of redialing attempts (C)	15	PA6 / 1 to 255
Access number (TAPnr)	-	PA6 / Max. 22 characters; 1, 2, 3, ..., 9, 0; "-" end of a string; "P" pause
Mobile phone number (HAndi)	-	PA6 / Max. 22 characters; 1, 2, 3, ..., 9, 0; "-" end of a string; "P" pause

* -> section 8.3 (Description of communication parameter settings)

8 Communication

Using the optional communications module, the EQJW126 Controller can communicate with a building control system. In combination with a suitable software for process visualization and communication, a complete control system can be implemented. The following communication settings are possible:

– **Operation with a dial-up modem to the RS-232/modem communications module**

Basically, communication is only established automatically when errors occur. The controller works autonomously. Nevertheless, the modem can dial up to the controller at any time to read data from it or otherwise influence it, if necessary.

– **Operation on a two-wire bus to the RS-485 communications module**

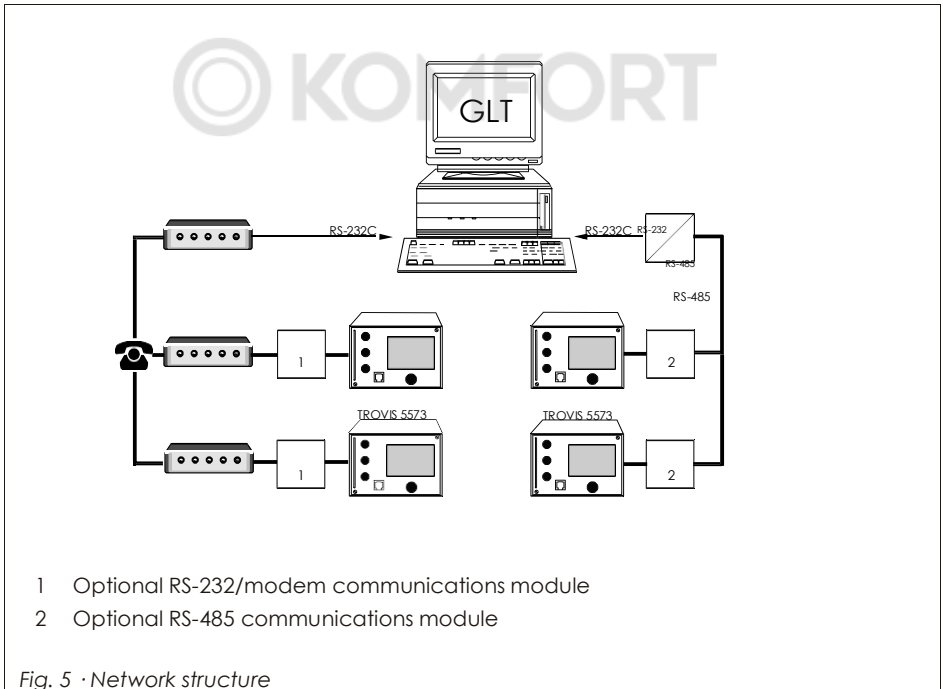

Note: The operating software can be updated over the modem or a data cable, provided Modbus is activated by configuring CO6 -> F01 - 1.

© KOMFORT

8.1 RS-232/modem communications module

When looking onto the controller front, the connection for the **optional** communications module is located on the left side in the controller housing (RJ-45 jack). A dial-up modem can be connected to the controller over the RS-232/modem communications module (8812-2004).

A dial-up modem is required in case the controller is to be connected to the telecommunications network. In this case, the controller works autonomously and can issue an alarm call to the building control station when errors occur. Additionally, the building control station can dial up to the controller, read data from it, and send new data once the valid key number has been written to

holding register no. 40145.

Note: *If a wrong key number has been written to holding register no. 40145 for the third consecutive time, the controller immediately interrupts the modem connection and generates an "Err 7" error message (Unauthorized access occurred). As a result, the call to the configured control system is triggered and a text message is sent. Bit D6 is deleted as soon as the error status register has been read by the control system and the connection has been terminated.*

In special cases, the **Lock dial-up** function can be selected to stop dial-up in case an error occurs. Using the **Dial-up also upon corrected error** function, the controller additionally informs the building control station when a previously signaled error no longer persists.

Thanks to the **Automatic modem configuration** function, the dial-up modem connected to the controller does not need to be preset; it is configured automatically by the controller.

Functions	WE	Configuration
Modbus	1	CO6 -> F01 - 1
Modbus 16-bit addressing	0	CO6 -> F02
Modem function	0	CO6 -> F03 - 1
Automatic modem configuration	0	CO6 -> F04 - 1
Lock dial-up	0	CO6 -> F05
Dial-up also upon corrected error	0	CO6 -> F06
Control system monitoring	0	CO6 -> F07 - C
Parameters*	WE	Parameter level / Range of values

Station address (ST) 255 PA6 / 1 to 247 with CO6 -> F02 - 1: 1 to 32000



Parameters*	WE	Parameter level / Range of values
Modem dialing pause (P)	5 min	PA6 / 0 to 255 min
Modem time-out (T)	5 min	PA6 / 1 to 255 min
No. of redialing attempts (C)	5	PA6 / 1 to 255
Phone no. of control station (TELnr)	-	PA6 / Max. 22 characters; 1, 2, 3, ...9, 0; "-" end of a string, "P" pause

* -> section 8.3 (Description of communication parametersettings)

8.2 RS-485 communications module

When looking onto the controller front, the connection for the **optional** communication module is located on the left side in the controller housing (RJ-45 jack). A constant bus connection is required (data cable) to operate the controller together with the RS-485 communication module (8812-2002). The bus line links the control units/devices in an open ring. At the end of the bus line, the data cable is connected to the control station using a RS-485/RS-232 converter (e.g. CoRe01, refer to Data Sheet T 5409 EN).

The maximum range of the bus connection (cable length) is 1,200 meters. A maximum of 126 devices can be connected to such a segment. For greater distances or when more than 126 devices are to be connected to a line, repeaters (e.g. CoRe01) must be used to regenerate the level. A maximum of 246 devices with 8-bit addressing can be connected to a bus.

If no communication is established between the control system and controller, the time of any access by the control system to dynamic process can be restricted by the **Control system monitoring** function. The controller resets the monitoring function, provided the valid Modbus requests are registered. However, in case of an error, all level bits are initialized back to "autonomous" after 30 minutes have elapsed.

NOTICE

You are required to follow the relevant standards and regulations concerning lightning and surge protection on installation.

Functions	WE	Configuration
Modbus	1	CO6 -> F01 - 1
Modbus16-bit addressing	0	CO6 -> F02
Modem function	0	CO6 -> F03 - 0
Control system monitoring	0	CO6 -> F07

Parameters*	WE	Parameter level / Range of values
Station address (ST.-NR) n s	255	PA6 / 1 to 247 with CO6 -> F02 - 1: 1 to 32000

* -> section 8.3 (Description of communication parameter settings)

8.3 Description of communication parameter settings

Station address (ST)

This address is used to identify the controller in bus or modem mode. In a system, each controller needs to be assigned a unique address.

Modem dialing pause (P)

It is recommendable to pause for approx. 3 to 5 minutes between dialing up to the control system/the text messaging center to avoid a permanent overloading of the telecommunications network. The *Modem dialing pause* defines the interval between 2 dialing attempts.

Modem time-out (T)

When the controller connects to the control station (GLT) but without addressing a Modbus data point, the connection is terminated after the time specified for *Modem time-out* has elapsed. If the error status register has not been read during the GLT connection, the controller dials up the GLT again after the *Modem dialing pause (P)* has elapsed. When sending a text message, the specified time is without meaning.

Number of redialing attempts (C)

The controller tries to dial up to the control system again, observing the *Modem dialing pause*, in case the GLT/text messaging center is busy or the function that triggered the call has not been reset by the controller. After the specified number of redialing attempts have failed, "OFF" is indicated in the controller's extended information level. The dialing attempt counter is automatically reset at 12:00h and the controller tries to connect again. Resetting of triggered call = Reading the error status registers (HR40150)

Phone number of control station (TELnr)

Enter the phone number of the control system modem including the dialing code, if necessary. Short pauses between the numbers can be entered using P (= 1 second); the end of the string is to be marked by "-". The phone number may include a maximum of 22 characters.

Example: "069, 2 sec. pause, 4009, 1 sec. pause, 0":

0 6 9 P P 4 0 0 9 P 0 - (= 11 characters)

Note: The connected modem is automatically configured when the function

block CO6 -> F04 - 1 is activated.



8.4 Meter bus/Modbus gateway

The controller can be connected (RJ-45 jack) to an optional meter bus/Modbus gateway (1400-9867). The gateway can communicate with up to six heat and water meters according to EN 1434-3. Flow rate or capacity limitation is possible on the basis of the values measured at heat meter WMZ1.

Details on the use of the different heat or water meters can be found in the technical documentation TV-SK 6311.

8.4.1 Activating the meter bus

To successfully transfer data from the heat meter to the gateway, the heat meter must use a standardized protocol in accordance with EN 1434-3. It is not possible to make a general statement about which specific data can be accessed in each meter. For details on the different meter makes, refer to the technical documentation TV-SK 6311. All necessary function block parameters to set up the communication with heat or water meters are available in CO6 -> F10. The meter bus address, the model code and the reading mode must be specified for the heat meters WMZ1 to WMZ6. A meter bus address must be unique and correspond with the address preset in the WMZ. If the preset meter bus address is unknown, a single heat meter connected to the gateway can be assigned the meter bus address 254. The address 255 deactivates the communication with the respective WMZ. The model code to be set for the heat meter can be found in TV-SK 6311. In general, the default setting of 1434 can be used for most devices. The meters can be read either automatically every 24 hours (approx.), continuously or when the coils (= Modbus data points) assigned to the heat meters WMZ1 to WMZ6 are overwritten with the value 1 via the system bus interface.

In extended information level, the flow rate and/or capacity value is displayed when the flow rate and/or capacity limitation is activated. Press the rotary pushbutton to read the corresponding limit value.

Note: *It may take up to two minutes until the controller enables access to CO6 -> F10 after the components (controller or gateway) have been rebooted.*

Functions	WE	Configuration
Meter bus	0	CO6 -> F10 - 1
	255	Meter bus address for WMZ 1 to 6 (ST.-NR) / 0 to 255
	1434	Model code WMZ 1 to 6 / 1434, CAL3, APAT0, SLS
	24h	Reading mode WMZ 1 to 6 / 24h, CONT, CoIL Tariff function option HT/NT, only selectable for WMZ1 on setting "1434" and "CONT": tAr-A: Function not active tAr-E: Depending on the following programmable time schedule, the consumption data are assigned to a high tariff or a low tariff. Three time periods can be entered per day of the week (not vacations or public holidays): 1-7 daily, 1 = Monday, 2 = Tuesday, ..., 7 = Sunday

8.4.2 Flow rate and/or capacity limitation using meter bus

The refreshing rate of the measured variable (flow rate and/or capacity) must be less than five seconds to ensure that the limitation can be performed properly. The technical documentation TV-SK 6311 lists the heat meters which comply with this criterion and, therefore, can be used for limitation. Note that some makes, particularly battery-operated heat meters, respond with communication pauses when they are read too frequently. Others might run out of energy early. For details, refer to TV-SK 6311.

Flow rate limitation

All function block parameters required to set up flow rate limitation are available in CO6 -> F11. The system's *Max. limit value* have to be set. The *Limiting factor* determines how strongly the controller responds when the limit values are exceeded in either direction. In extended operating level, the data point *Flow rate* [m³/h] in conjunction with square 1 at the top display indicates that the flow rate limitation is active. Press the rotary pushbutton to display the current max.

limit value.

Note: If CO5 -> F00 - 1 is indicated, access to the return flow, flow rate and heat capacity settings are locked

Functions	WE	Configuration
Meter bus	0	CO6 -> F10 - 1
	255	Meter bus address WMZ 1 to 6 (ST.-NR) / 0 to 255

1434	Model code WMZ 1 to 6 / 1434, CAL3, APAtO, SLS
24h	Reading mode WMZ 1 to 6 / 24h, CONT, CoIL



Flow rate limitation in Rk1 using 0 meter bus	1.5 m ³ _h	CO6 -> F11 - 1 Max. limit value* / 0.01 to 650 m ³ _h
	1.0	Limiting factor / 0.1 to 10.0

* Icons of the maximum limit values on the display: System -> "Flow rate" and "Fixed set point"

Capacity limitation

All function block parameters required to set up capacity limitation are available in CO6 -> F12. The systems's *Max. limit value* has to be set. The *Limiting factor* determines how strongly the controller responds when the limit values are exceeded in either direction.

In extended operating level, the data point *Capacity* [kW] in conjunction with square 1 at the top display indicates that the capacity limitation is active in. Press the rotary pushbutton to display the current max. limit value.



Note: If CO5 -> F00 - 1 is indicated, access to the return flow, flow rate and heat capacity settings are locked.

Functions	WE	Configuration
Meter bus	0	CO6 -> F10 - 1
	255 to 1434	Meter bus address WMZ 1 to 6 (ST.-NR) / 0 255
	24h	Model code WMZ 1 to 6 / 1434, CAL3, APAtO, SLS Reading mode WMZ 1 to 6 / 24h, CONT, Coil
Capacity limitation in Rk1 using meter bus	0	CO6 -> F12 - 1
	1.5 kW 1.0	Max. limit value* / 0.01 to 6500kW Limiting factor / 0.1 to 10.0
* Icons of the maximum limit values on the display: "Flow rate" and "Fixed set point" and "Radiator"		

8.5 Memory module

The use of a memory module (0440210010) is particularly useful to transfer all data from one EQJW126 Controller to several other EQJW126 Controllers.





The memory module is plugged into the RJ-45 jack at the side. Once the module has been connected, "73 SP" is displayed. If the memory module already contains data from a different EQJW126 Controller, turn the rotary pushbutton until "SP 73" is displayed.

-  Pressing the rotary pushbutton to confirm "73 SP" causes the controller settings to be transferred to the memory module.
-  Pressing the rotary pushbutton to confirm "SP 73" causes the saved controller settings to be transferred from the memory module to the controller.

During the data transfer, the bars on the display indicate the progress. When the transfer was successful, "I.O." is displayed. After that, the connection between controller and memory module can be terminated.

8.6 Data logging

A data logging module (0440210009) saves the following controller data every two minutes:

-  Temperatures measured by the sensors
-  Control signals [%]
-  Switching states of the pump outputs
-  Error status register and its archive data
-  Access to the controller settings

The data logging module is connected to the RJ-45 jack at the side of the controller.

The controller starts to write over the oldest data as soon the memory of the data logging module is full after approximately eight days. The current memory capacity of the data logging module can be read in the extended information level under *Info 2* as the second in the sequence (range of values: 0 to 6035). Directly after inserting the data logging module, data can be first read after the first scanning cycle has been performed.

The data log viewer software allows the data to be viewed in graph format. The USB converter 3 (0440210007) is required to connect the data logging module to a computer. The data log viewer software is supplied with the USB converter 3.



9 Installation

The controller is available either with a standard back panel or a high back panel.

Dimensions in mm (W x H x D)

 Controller with standard back panel : 144 x 98 x 54

The controller consists of the housing with the electronics and the back panel with the terminals. It is suitable for panel, wall and top hat rail mounting (Fig. 6).

Panel mounting

1. Remove both screws (1).
2. Pull apart the controller housing and the back panel.
3. Make a cut-out of 138 x 92 mm (W x H) in the control panel.
4. Insert the controller housing through the panel cut-out.
5. Tighten the two screws (2) to clamp the controller housing against the control panel.
6. Connect the electrical wiring at the back of the housing as described in section 11.
7. Fit the controller housing.
8. Fasten both screws (1).

Wall mounting

1. Remove both screws (1).
2. Pull apart the controller housing and the back panel.
3. If necessary, drill holes with the specified dimensions in the appropriate places. Fasten the back panel with four screws.
4. Connect the electrical wiring at the back of the housing as described in section 11.
5. Remount the controller housing.
6. Fasten both screws (1).

Panel mounting

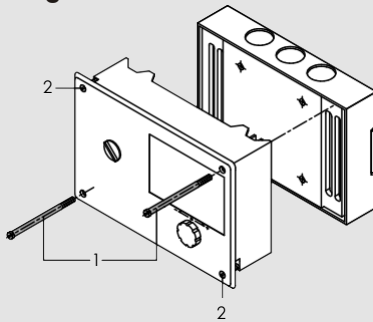

Wall mounting

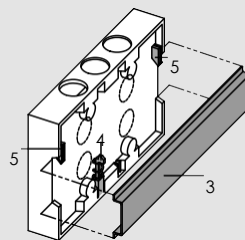
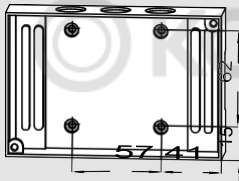

Top hat rail mounting

Fig. 6 · Installation

Top hat rail mounting

1. Fasten the spring-loaded hook (4) at the bottom of the top hat rail (3).
2. Slightly push the controller upwards and pull the upper hook (5) over the top hat rail.
3. Remove both screws (1).
4. Pull apart the controller housing and the back panel.
5. Install the electrical connections at the back panel as described in section 11.
6. Remount the controller housing.
7. Fasten both screws (1).







10 Electrical connection

DANGER!



Risk of electric shock!

For electrical installation, you are required to observe the relevant electrotechnical regulations of the country of use as well as the regulations of the local power suppliers. Make sure all electrical connections are installed by trained and experienced personnel!

Notes on installing the electrical connections

-  Install the 230 V power supply lines and the signal lines separately! To increase noise immunity, observe a minimum distance of 10 cm between the lines. Make sure the minimum distance is also observed when the lines are installed in a cabinet.
-  The lines for digital signals (bus lines) and analog signals (sensor lines, analog out-puts) must also be installed separately!
-  In plants with a high electromagnetic noise level, we recommend to use shielded cables for the analog signal lines. Ground the shield at one side, either at the control cabinet inlet or outlet, using the largest possible cross-section. Connect the central grounding point and the PE grounding conductor with a cable $\geq 10 \text{ mm}^2$ using the shortest route.
-  Inductances in the control cabinet, e.g. contactor coils, are to be equipped with suitable interference suppressors (RC elements).
-  Control cabinet elements with high field strength, e.g. transformers or frequency converters, should be shielded with separators providing a good ground connection.

Overvoltage protection

-  If signal lines are installed outside buildings or over large distances, make sure appropriate surge or overvoltage protection measures are taken. Such measures are indispensable for bus lines!
-  The shield of signal lines installed outside buildings must have current conducting capacity and must be grounded on both sides.
-  Surge diverters must be installed at the control cabinet inlet.

Connecting the controller

The controller is connected as illustrated in the following wiring diagram.

Open the housing to connect the cables. To connect the feeding cables, make holes in the marked locations at the top, bottom or back of the rear part of the housing and fit suitable grommets or cable glands.

60 BA_EQJW126F001_EN001



© KOMFORT

Connecting the sensors

Cables with a minimum cross-section of $2 \times 0.5 \text{ mm}^2$ can be connected to the terminals at the back panel of the housing.

Connecting the actuators



Three-step or on/off outputs:

Connect cables with at least 1.5 mm^2 suitable for damp locations to the terminals of the controller output (right side). The direction of travel needs to be checked at start-up.

Connecting the pumps

Connect all cables with at least 1.5 mm^2 to the terminals of the controller as illustrated in the wiring diagram.



Legend for wiring diagram:

AF Outdoor
sensor Rk Control
circuit
UP Circulation pump
(heating) RF Room
sensor
RÜF Return flow sensor
VF Flow sensor

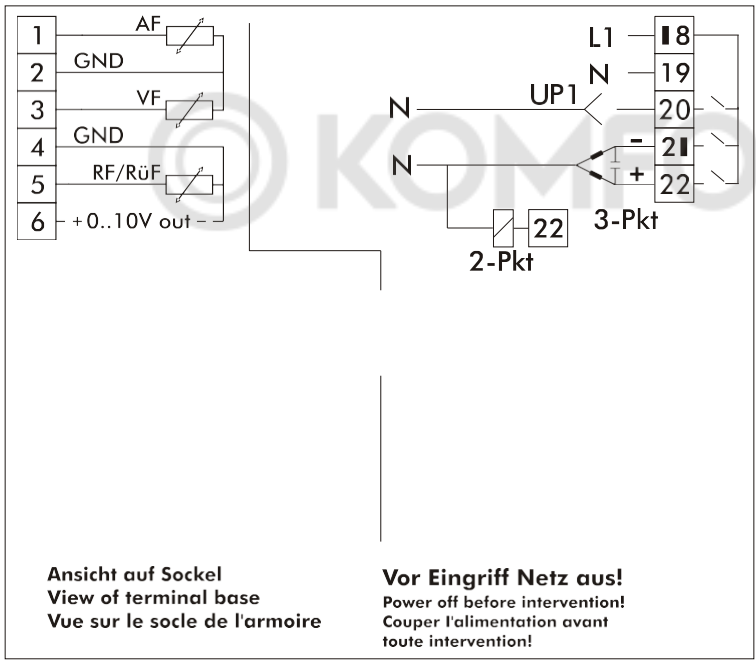

Fig. 7 Connecting the EQJW126 Controller with standard back panel

12 Appendix

12.1 Function block lists

CO1: Rk1· Heating circuit 1

F	Function	WE	Anl	Comment Function block parameters / Range of values (default)
01	Room sensor RF	0	Not in Anl 1.5, 1.6, 3.x	CO1 -> F01 - 1: Temperature display and input FG1 for Type 5257-5 Room Panel active
02	Outdoor sensor AF	0	1.5, 1.6	CO1 -> F02 - 1: Weather-compensated control active
		1	Not in Anl 1.5, 1.6	
03	Return flow sensor RÜF	0	1.2	CO1 -> F03 - 1: Sensor and limiting function active Function block parameter: KP (limiting factor) / 0.1 to 10.0 (1.0)
		1	Not in Anl 1.2	
04	Cooling control	0	All*	CO1 -> F04 - 1: Cooling control, only with CO1 -> F11 - 1 The cooling control causes the reversal of the operating direction and a minimum limitation of the return flow temperature in Rk1.
05	Underfloor heating Drying of jointless floors	0	Not in Anl 1.5, 1.6, 3.x	CO1 -> F05 - 1: Limitation of the adjustment ranges Function block parameters: Start temperature / 20 to 60 °C (25 °C) Temperature rise per day / 0.0 to 10.0 °C (5.0 °C) Maximum temperature / 25.0 to 60.0 °C (45.0 °C) Maintaining time of max. temp. / 0 to 10 days (4 days) Temperature reduction per day / 0.0 to 10.0 °C (0.0 °C) SToP, ,STArT, ,STArT, _STArT
07	Optimization	0	Not in Anl 1.5, 1.6, 3.x	CO1 -> F07 - 1: Only with • CO1 -> F01 - 1 • CO1 -> F02 - 1
08	Adaptation	0	Not in Anl 1.5, 1.6, 3.x	CO1 -> F08 - 1: Only with • CO1 -> F01 - 1 • CO1 -> F02 - 1 • CO1 -> F11 - 0
09	Flash adaptation	0	Not in Anl 1.5, 1.6, 3.x	CO1 -> F09 - 1 Only with CO1 -> F01 - 1 Function block parameters: Cycle time / 0 or 1 to 100 min (20 min) KP (gain) / 0.0 to 25.0 (0.0)

			Comment	
F	Function	WE	Anl	Function block parameters / Range of values (default)
11	Four-point characteristic	0	Not in Anl 1.5, 1.6	CO1 -> F11 - 1: Four-point characteristic, only with CO1 -> F08 - 0 CO1 -> F11 - 0: Gradient characteristic
12	Control mode	1	All*	CO1 -> F12 - 1: three-step control Function block parameters: KP (proportional gain) / 0.1 to 50.0 (2.0) Tn (reset time) / 1 to 999 s (120 s) TV (derivative-action time) / 0 to 999 s (0 s) TY (valve transit time) / 5, 10, 15, ..., 240 s (45 s) CO1 -> F12 - 0: On/off control Function block parameters: Hysteresis / 1.0 to 30.0 °C (5.0 °C) Min. ON time / 0 to 10 min (2 min) Min. OFF time / 0 to 10 min (2 min)
13	Limitation of deviation for OPEN signal	0	All*	CO1 -> F13 - 1 only with CO1 -> F12 - 1 Function block parameter: Max. deviation / 2.0 to 10.0 °C (2.0 °C)
14	Release Rk1 at BE1	0	All*	With CO1 -> F14 - 1, FG1 has no function; Options bE= 1, bE=0 (bE=1)
15	Processing an external demand in Rk1	0	All*	How the external demand is processed in Rk1 depends on CO1 -> F16, CO1 -> F17 and CO7 -> F15.
16	Processing an external demand, 0 to 10 V Input term. 11/12	0	All*	CO1 -> F16 - 1: Only with • CO1 -> F15 - 1 • CO1 -> F17 - 0 Function block parameters: Lower transmission range: 0.0 to 130.0 °C (0.0 °C) Upper transmission range: 0.0 to 130.0 °C (120.0 °C) The standard signal output (terminals 11/12) is not available anymore as a control output.
17	Processing an external demand, binary Input term. 03/12	0	Not in Anl with SF2/RF2	CO1 -> F17 - 1: Only with • CO1 -> F15 - 1 • CO1 -> F16 - 0 Options bE= 1, bE=0 (bE=1)

F Function		WE	Anl	Comment Function block parameters / Range of values (default)
18	Request max. flow set point by issuing a 0 to 10 V signal	0	All*	CO1 -> F18 - 1: The standard signal output (terminals 11/12) is not available anymore as a control output. The maximum flow set point (with boost, if applicable) is demanded by issuing the signal output (0 to 10 V). Function block parameters: Lower transmission range: 0.0 to 130.0 °C (0.0 °C) Upper transmission range: 0.0 to 130.0 °C (120.0 °C) Boost of flow temperature demand: 0 to 30 °C (0 °C)
20	External demand for heat due to insufficient heat supply	0	All	CO1 -> F20 - 1: Demand for an external heat source

F Function block number, WE Default value, Anl System code number



CO5: System-wide functions (all systems)

If CO5 -> F00 - 1 is indicated, access to the return flow, flow rate and heat capacity settings are locked.

F	Function	WE	Anl	Comment Function block parameters / Range of values (default)
01	Sensor initialization	1	All	CO5-> F01 - 1, F02 - 0, F03 - 0 Pt 1000
02		1		CO5-> F01 - 1, F02 - 1, F03 - 0 Ni 1000 DIN
03		0		CO5-> F01 - 1, F02 - 1, F03 - 0, CO9-> F01 - 1 Ni 1000-5k
04	Summer mode	0	Not Anl 1.5, 1.6, 1.9, 3.5	CO5 -> F04 - 1: Activation of time-controlled summer mode Function block parameters: Start summer mode / 01.01 to 31.12 (01.06) No. of days until activation / 1 to 3 (2) Stop summer mode / 01.01 to 31.12 (30.09) No. of days until deactivation / 1 to 3 (1) Outdoor temperature limit for summer mode / 0.0 to 30.0 °C (18.0 °C)
05	Delayed outdoor temperature adaptation when temperature decreases	0	Not Anl 1.9	CO5 -> F05, 06 - 1: Function block parameter: Delay per hour/ 1.0 to 6.0 °C (3.0 °C)
06	Delayed outdoor temperature adaptation when temperature increases	0	Not Anl 1.9	
08	Automatic summer time/winter time changeover	1	All	
09	Frost protection program II	1	Not Anl 1.5, 1.6, 1.9, 3.5	CO5 -> F09 - 0: Frost protection program I (restricted frost protection) Function block parameter: Frost protection limit / -15.0 to 3.0 °C (3.0 °C)
		0	1.5, 1.6, 1.9, 3.5	CO5 -> F09 - 1: Frost protection program II Function block parameter: Frost protection limit / -15.0 to 3.0 °C (3.0 °C)

F	Function	WE	Anl	Comment Function block parameters / Range of values (default)
15	Release controller at BE1	0	All	CO5 -> F15 - 1: FG1 has no function Select bE= 1, bE=0 (bE=1)
16	Return flow temperature limitation with P algorithm	0	All	CO5 -> F16 - 1: Return flow temperature limitation with P-action only
19	Temperature monitoring	0	All	CO5 -> F19 - 1: Temperature monitoring active
20	Sensor calibration	1	All	CO5 -> F20 - 1: Adjusting all sensor calibration values CO5 -> F20 - 0: Deleting all adjusted sensor calibration values
21	Locking manual level	0	All	CO5 -> F21 - 1: In switch position , automatic mode applies
22	Locking the rotary switch	0	All	CO5 -> F22 - 1: Rotary switch without function – Access after entering key number still possible.
23	Outdoor temperature received over 0 to 10 V input	0	All	CO5 -> F23 - 1: Outdoor temperature received over 0 to 10 V input (terminal 11/12) Function block parameters: Lower transmission range / –30 to 100 °C (–20 °C) Upper transmission range / –30 to 100 °C (50 °C)
				*Not in systems Anl 1.0, 1.5, 1.6, 3.0, 3.5, 4.0, 11.x

F Function block number, WE Default value, Anl System code number

CO6: Modbus (all systems)



F	Function	WE	Anl	Comment Function block parameters / Range of values (default)
01	Modbus	1	All	CO6 -> F01 - 1: Modbus active
02	Modbus 16-bit addressing	0	All	CO6 -> F02 - 1: 16-bit address, only with CO6 -> F01 - 1 CO6 -> F02 - 0: 8-bit addressing
03	Mode m function	0	All	CO6 -> F03 - 1 Only with <ul style="list-style-type: none"> • CO6 -> F01 - 1 • CO6 -> F08 - 1
04	Automatic modem configuration	0	All	CO6 -> F04 - 1 Only with <ul style="list-style-type: none"> • CO6 -> F03 - 1 • CO6 -> F08 - 1
05	Lock dial-up	0	All	CO6 -> F05 - 1: No dial-up to GLT in case of error, only with CO6 -> F03 - 1
06	Dial-up also upon corrected error	0	All	CO6 -> F06 - 1: Dial-up to GLT also to indicate that an error has been corrected, only with CO6 -> F03 - 1
07	Control system monitoring	0	All	CO6 -> F07 - 1: Resetting all level bits to "autonomous" when there is no communication, only with CO6 -> F01 - 1
08	Text message	0	All	CO6 -> F08 - 1: Sending of text message active
10	Meter bus (only with optional, meter bus/Modbus gateway)	0	All	CO6 -> F10 - 1: Meter bus active Function block parameters: (for WMZ1 to WMZ3) Meter bus address / 0 to 255 (255) Model code / 1434, CAL3, APAtO, SLS (1434) Reading mode / 24h, CONT, Coil (24h) For WMZ1 with "1434" and "CONT", select: tAr-A, tAr-E with time schedule
11	Flow rate limitation in Rk1 using meter bus	0	Not Anl 1.9	CO6 -> F11 - 1: Only with <ul style="list-style-type: none"> • CO6 -> F10 - 1 • CO5 -> F11 - 0 Function block parameters: Max. limit value / 0.01 to 650 $\frac{m^3}{h}$ (1.5 $\frac{m^3}{h}$) Limiting factor / 0.1 to 10 (1)
12	Capacity limitation in Rk1 using meter bus	0	Not Anl 1.9	CO6 -> F12 - 1: Only with <ul style="list-style-type: none"> • CO6 -> F10 - 1 • CO5 -> F10 - 0 Function block parameters: Max. limit value / 0.1 to 6500 kW (1.5 kW) Limiting factor / 0.1 to 10 (1.0)
				* Not in Anl 1.0, 1.5-1.9, 3.0, 4.0, 7.x, 10.0, 11.x

F Function block number, WE Default value, Anl System code number

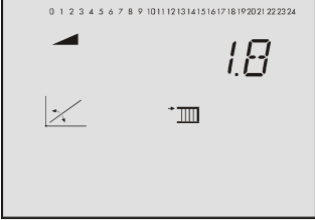
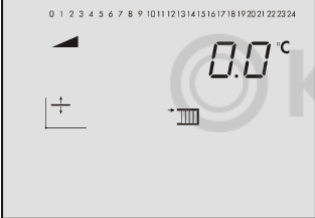

12.2 Parameter lists

PA1: Parameters Rk1 (heating circuit 1)

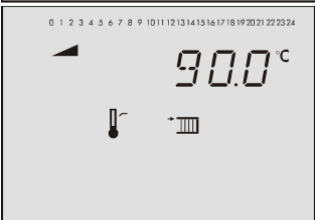
Display	Parameter designation
	Range of values (default) Gradient, flow 0.2 to 3.2 (1.8) (with CO1 -> F05 - 1: 0.2 to 1.0 (1.0) applies)
	Level (parallel shift) -30.0 to 30.0 °C (0.0 °C)
	Min. flow temperature 5.0 to 130.0 °C (20.0 °C)
	Max. flow temperature 5.0 to 130.0 °C (90.0 °C) (with CO1, 2, 3 -> F05 - 1: 5.0 to 50.0 °C (50.0 °C) applies)

Display

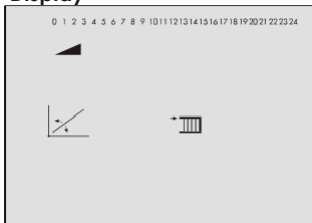

Parameter designation

Range of values

(default) Four-point characteristic

Press rotary pushbutton  to set the following parameters:
 outdoor temperature,
 flow temperature,
 reduced flow temperature and
 return flow temperature



Four-point characteristic
 Point 1: Outdoor temperature

Outdoor temperatures of the points 2, 3, 4 are marked by squares below the numbers 2, 3, 4.
 -30.0 to 50.0 °C
 (point 1: -15.0 °C, point 2: -5.0 °C, point 3: 5.0 °C, point 4: 15.0 °C)

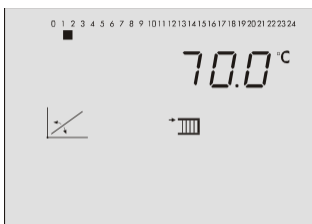

Four-point characteristic
 Point 1: Flow temperature

Flow temperatures of the points 2, 3, 4 are marked by squares below the numbers 2, 3, 4.
 5.0 to 130.0 °C
 (point 1: 70.0 °C, point 2: 55.0 °C, point 3: 40.0 °C, point 4: 25.0 °C)

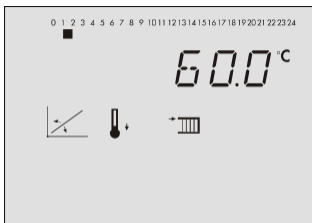

Four-point characteristic
 Point 1: Reduced flow temperature

Reduced flow temperatures of the points 2, 3, 4 are marked by squares below the numbers 2, 3, 4.
 5.0 to 130.0 °C
 (point 1: 60.0 °C, point 2: 40.0 °C, point 3: 20.0 °C, point 4: 20.0 °C)

© KOMFORT

Display

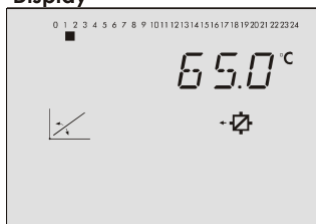

Parameter designation

Range of values

(default) Four-point characteristic
Point 1: Return flow temperature

Return flow temperatures of the points 2, 3, 4 are marked by squares below the numbers 2, 3, 4.

5.0 to 90.0 °C
(points 1 to 4: 65.0 °C)



OT deactivation value in rated operation

0.0 to 50.0 °C (22.0 °C)



OT deactivation value in reduced operation

-20.0 to 50.0 °C (15.0 °C)

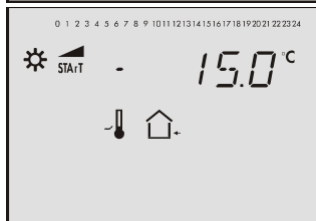

OT activation value in rated operation

-20.0 to 5.0 °C (-15.0 °C)

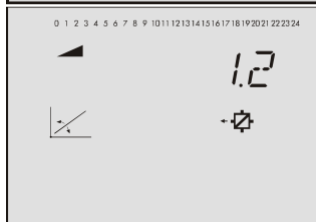

Gradient, return

flow 0.2 to 3.2 (1.2)

Display

Parameter designation

Range of values

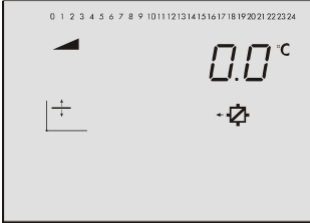

(default) Level, return flow
-30.0 to 30.0 °C (0.0 °C)

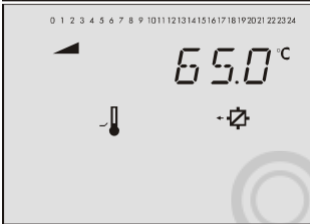

Base point for return flow temperature
5.0 to 90.0 °C (65.0 °C)

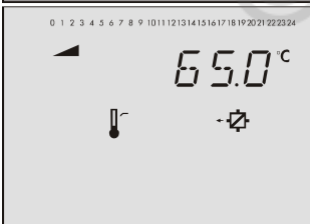

Max. return flow temperature
5.0 to 90.0 °C (65.0 °C)

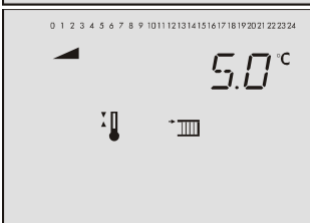

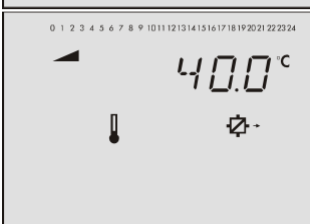

Set point boost of primary exchanger
control 0.0 to 50.0 °C (5.0 °C)

Only in PA1 parameter level



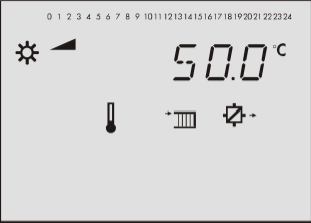

Set point for binary demand
processing 5.0 to 130.0 °C (40.0 °C)

Only in PA1 parameter level

Display	Parameter designation
	Range of values (default) Day set point for flow temperature 5.0 to 130.0 °C (50.0 °C) Only for flash adaptation without outdoor sensor
	Night set point for flow temperature 5.0 to 130.0 °C (30.0 °C) Only for flash adaptation without outdoor sensor

PA5: System-wide parameters (all systems)

Display	Parameter designation
	Public holidays (01.01 to 31.12 → section 1.8.1)
	Vacation periods (01.01 to 31.12 → section 1.8.2)

PA6: Modbus parameters

Display

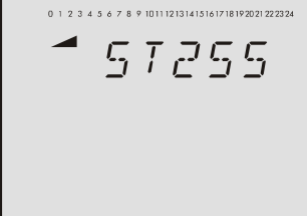
**Parameter designation**

Range of values
(default) Station
address (ST)

1 to 247 (255)
(with CO6 -> F02 - 1: 1 to 32000 applies)

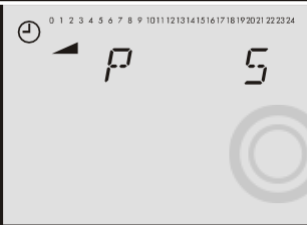

Modem dialing pause

(P) 0 to 255 min (5 min)

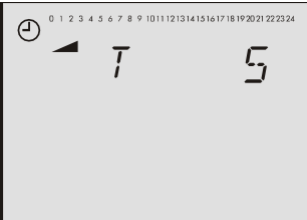

Modem time-out

(T) 1 to 255 min (5
min)

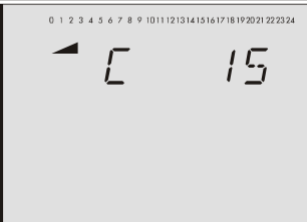

Number of redialing attempts to building control station

(C) 1 to 255 (15)

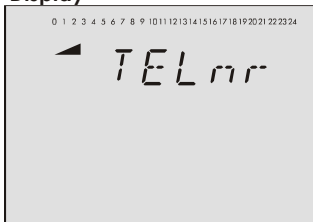
Display**Parameter designation**

Range of values (default)

Phone number of control station (TELnr)

Max. 22 characters; 1, 2, 3, ..., 9, 0;

"- " = end of a string

"P" = pause



Access number (TAPnr)

Max. 22 characters; 1, 2, 3, ..., 9, 0;

"- " = end of a string

"P" = pause

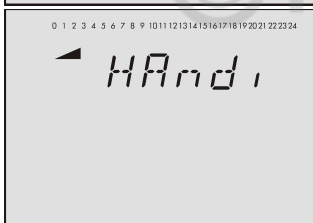

Mobile phone number (HAndi)

Max. 22 characters; 1, 2, 3, ..., 9, 0;

"- " = end of a string

"P" = pause

12.3 Sensor resistance tables

Resistance values with Pt 1000 resistors

Type 5227-2 Outdoor Temperature Sensor, Type 5277-2 Flow and Return Flow Temperature Sensor, Type 5267-2 (contact sensor) Flow and Return Flow Temperature Sensor.

Type 5257-1, Type 5257-5 (room panel) Room Temperature Sensors.

°C	-35	-30	-25	-20	-15	-10	-5	0	5	10
Ω	862.5	882.2	901.9	921.6	941.2	960.9	980.4	1000.0	1019.5	1039.0
°C	15	20	25	30	35	40	45	50	55	60
Ω	1058.5	1077.9	1097.3	1116.7	1136.1	1155.4	1174.7	1194.0	1213.2	1232.4
°C	65	70	75	80	85	90	95	100	105	110
Ω	1251.6	1270.7	1289.8	1308.9	1328.0	1347.0	1366.0	1385.0	1403.9	1422.9
°C	115	120	125	130	135	140	145	150		
Ω	1441.7	1460.6	1479.4	1498.2	1517.0	1535.8	1554.5	1573.1		

12.4 Technical data

Inputs	3 inputs for Pt 1000 temperature sensors
Outputs	1 x pump output: load max. 250 V AC, 2A 1 x three-step signal: load max. 250 V AC, 2A all 250V outputs as relay outputs with varistor suppressor
Optional interfaces	1 x Modbus RS-232 interface for modem using RS-232/modem communication module 1 x Modbus RS-485 interface for two-wire bus using RS-485 communication module (Modbus RTU protocol, data format 8N1, RJ-45 jack at the side)
Operating voltage	85 to 250 V, 48 to 62 Hz, max. 1.5 VA
Ambient temperature	0 to 40 °C (operation), -10 °C to 60 °C (storage and transport)
Degree of protection	IP 40 according to IEC 529
Class of protection	II according to VDE 0106
Degree of contamination	2 according to VDE 0110
Overvoltage category	II according to VDE 0110
Humidity rating	F according to VDE 40040
Noise immunity	According to EN 61000-6-1
Noise emission	According to EN 61000-6-3
Weight	Approx. 0.5 kg

12.5 Customer data

Station	
Operator	
Office	
System code number	

Function block settings in configuration levels

	CO 1	CO 4	CO 5	CO 6
F01				
F02				
F03				
F04				
F05				
F06				
F07				
F08				
F09				
F10				
F11				
F12				
F13				
F14				
F15				
F16				
F17				
F18				
F19				
F20				
F21				
F22				
F23				

Rk1 (heating circuit 1)

Parameters in levels 1 and 2	PA1	Range of values
Gradient, flow		0.2 to 3.2
Level, flow		-30.0 to 30.0 °C
Min. flow temperature		5.0 to 130.0 °C
Max. flow temperature		5.0 to 130.0 °C
Four-point characteristic		
Outdoor temperature; point 1		-30.0 to 50.0 °C
Outdoor temperature; point 2		-30.0 to 50.0 °C
Outdoor temperature; point 3		-30.0 to 50.0 °C
Outdoor temperature; point 4		-30.0 to 50.0 °C
Flow temperature; point 1		5.0 to 130.0 °C
Flow temperature; point 2		5.0 to 130.0 °C
Flow temperature; point 3		5.0 to 130.0 °C
Flow temperature; point 4		5.0 to 130.0 °C
Reduced flow temperature; point 1		5.0 to 130.0 °C
Reduced flow temperature; point 2		5.0 to 130.0 °C
Reduced flow temperature; point 3		5.0 to 130.0 °C
Reduced flow temperature; point 4		5.0 to 130.0 °C
Return flow temperature; point 1		5.0 to 90.0 °C
Return flow temperature; point 2		5.0 to 90.0 °C
Return flow temperature; point 3		5.0 to 90.0 °C
Return flow temperature; point 4		5.0 to 90.0 °C
Flow rate; point 1		At, 0.01 to 650 m ³ /h
Flow rate; point 2		At, 0.01 to 650 m ³ /h
Flow rate; point 3		At, 0.01 to 650 m ³ /h
Flow rate; point 4		At, 0.01 to 650 m ³ /h
Capacity; point 1		At, 0.1 to 6500 kW
Capacity; point 2		At, 0.1 to 6500 kW
Capacity; point 3		At, 0.1 to 6500 kW
Capacity; point 4		At, 0.1 to 6500 kW

OT deactivation value in rated operation		0.0 to 50.0 °C
OT deactivation value in reduced operation		-20.0 to 50.0 °C
OT activation value in rated operation		-20.0 to 5.0 °C
Gradient, return flow		0.2 to 3.2
Level, return flow		-30.0 to 30.0 °C
Base point for return flow temperature		5.0 to 90.0 °C
Max. return flow temperature		5.0 to 90.0 °C
Parameters	PA1	Range of values
Day set point for flow temperature		5.0 to 130.0 °C
Night set point for flow temperature		5.0 to 130.0 °C
Set point boost of primary heat exchanger control		0.0 to 50.0 °C
Set point for binary demand processing		5.0 to 130.0 °C
Function block parameters	CO1	Range of values
F03 - 1: KP (limiting factor)		0.1 to 10.0
F05 - 1: Start temperature		20 to 60 °C
F05 - 1: Temperature rise per day		0.0 to 10.0 °C
F05 - 1: Maximum temperature		25.0 to 60.0 °C
F05 - 1: Maintaining time of max. temp.		0 to 10 days
F05 - 1: Temperature reduction per day		0.0 to 10.0 °C
F09 - 1: Cycle time		0/1 to 100 min
F09 - 1: KP (gain)		0.0 to 25.0
F12 - 1: KP (proportional gain)		0.1 to 50.0
F12 - 1: Tn (reset time)		1 to 999 s
F12 - 1: TV (derivative-action time)		0 to 999 s
F12 - 1: TY (valve transit time)		5 to 240 s
F12 - 0: Hysteresis		1.0 to 30.0 °C
F12 - 0: Min. ON time		0 to 10 min
F12 - 0: Min. OFF time		0 to 10 min
F13 - 1: Max. deviation		2.0 to 10.0 °C

Parameters in PA5 level

Parameters	PA5					Range of values
Public holidays						01.0 1 to 31.12
Vacation periods, start						01.0 1 to 31.12
Vacation periods, stop						12 3
Assignment to control circuit						12 3
Vacation periods, start						01.0 1 to 31.12
Vacation periods, stop						12 3
Assignment to control circuit						12 3
Function block parameters	CO5					Range of values
F04 - 1: Start summer mode						01.0 to 31.12 1
F04 - 1: No. of days until activation						1 to 3
F04 - 1: Stop summer mode						01.0 to 31.12 1
F04 - 1: No. of days until deactivation						1 to 3
F04 - 1: Outdoor temperature limit						0.0 to 30.0 °C
F05/6 - 1: Delay per hour						1.0 to 6.0 °C
F09 - 0/- 1: Frost protection limit						-15.0 to 3.0 °C
F12-1: Input						bin, AnA
F12-1: bin, binary input						bE=1, bE=0
F15-1: Binary input						bE=1, bE=0
F23 - 1: Lower transmission range						-30 to 100 °C
F23 - 1: Upper transmission range						-30 to 100 °C

Parameters in PA6 level



Parameters	PA6	Range of values
Station address (ST)		1 to 247 1 to 32000

Modem dialing pause (P)		0 to 255 min
Modem time-out (T)		1 to 255 min
Number of redialing attempts (C)		1 to 255
Phone no. of control station (TELnr)		–
Access number (TAPnr)		–
Mobile phone number (HAndi)		–
Function block parameters (CO6)	Level 6	Range of values
Meter bus address WMZ1 to WMZ6 (F10 - 1)		0 to 255
Model code WMZ1 to WMZ6 (F10 - 1)		APAtO, CAL3, 1434, SLS
Reading mode WMZ1 to WMZ6 (F10 - 1)		COIL, 24h, CONT
Max. limit value (F11 - 1)		0.01 to 650 ^m _h
Limiting factor (F11 - 1)		0.1 to 10
Max. limit value (F12 - 1)		0.1 to 6500 kW
Limiting factor (F12 - 1)		0.1 to 10
Max. limit value (F13 - 1)		0.01 to 650 ^m _h
Limiting factor (F13 - 1)		0.1 to 10
Max. limit value (F14 - 1)		0.1 to 6500 kW
Limiting factor (F14 - 1)		0.1 to 10

Function block parameters	CO8	Range of values
F01 - 1: Error message at		BE =0, BE = 1, none
F01 - 2: Error message at		BE =0, BE = 1, none

Settings at the rotary switch

Heating circuit 1 · Display: 1

Parameters	Range of values						
 Day set point	0.0 to 40.0 °C 5.0 to 130.0 °C						
 Night set point	0.0 to 40.0 °C 5.0 to 130.0 °C						
Times-of-use	Mon	Tue	Wed	Thu	Fri	Sat	Sun
Start of first time-of-use							
End of first time-of-use							
Start of second time-of-use							
End of second time-of-use							
Start of third time-of-use							
End of third time-of-use							

Index

A

Adaptation 36
 Automatic mode 6

C

Capacity limitation..... 54 -55
 Characteristic..... 25
 Communication parameters 52
 Communications module

RS-232/modem 50
 RS-485..... 51

Condensate accumulation control ... 41
 Configuration level..... 65,
 70

Connection

Actuator 61
 Controller 60
 Pump..... 61
 Sensor..... 61

Continuous control..... 42

Control

continuous 42
 on/off 42
 three-step..... 42

Control station, phone number 52

Control system monitoring 51

Controller ID..... 12, 48

Controller time 9

Cooling control 37

Customer data..... 80

Cyclical initialization..... 52

D

Data logging 56

Data logging module 12, 56

Day mode..... 6

Day set point 27

Default settings 22

Delayed outdoor temp. adaptation . . .

33 Drying of jointless floors..... 29

E

Electrical connection . . . 41 - 44, 52 - 56,
 60 - 64

Error 45

Error messages

confirming error messages 45

Error status register 46

F

Fixed set point control..... 29

Flash adaptation

outdoor temperature dependent . .
 35 room temperature dependent 35

Flow rate limitation 54 - 55

Forced operation, pumps 39

Four-point characteristic 28

Frost protection..... 39

Function block lists..... 65, 70

Function block number 18

Functions, activating and deactivating . 18

G

Gradient characteristic 25 - 26

H

Heating characteristic 25

I

Information level 8

extended 12

Installation

Panel mounting..... 57

Top hat rail mounting 59

Wall mounting 57

J

Jointless floors, drying 29

- K**
- Key number.....18
 - Key number, customized.....44
- L**
- Level structure.....16
 - Locking
 - Rotary switch.....44
- M**
- Manual level5
 - locking.....43
 - Manual mode.....6, 23
 - Memory module.....56
 - Meter bus gateway.....53, 55
 - Modbus gateway53, 55
 - Modem dialing pause.....52
 - Modem redialing attempts, number of 52
 - Modem time-out.....52
- N**
- Network structure49
 - Night mode6
 - Night set point.....27
- O**
- On/off control.....42
 - Operating controls.....5
 - Operating modes6
 - Operational faults40, 45 - 48
 - Outdoor temperature adaptation, delay- ed.....33
 - Outdoor temperature, deactivation . . . 31
 - Overvoltage protection60
- P**
- Parameter lists.....71, 77
 - Parameters, changing20
 - Party mode11
 - Public holidays.....13
- Pumps, forced operation39
- Pumps, switching to manual mode 23
- R**
- RS-232.....50
 - RS-485.....51
 - Rated operation.....6
 - Reduced operation.....6
 - Resistance values.....77
 - Return flow temperature limitation . . . 40
 - Rotary pushbutton5
 - Rotary switch.....5
 - locking.....44
- S**
- Sensor calibration.....21
 - Sensor failure46
 - Set point
 - DHW temperature16
 - day.....16, 27
 - night.....16, 27
 - Stand-by mode6
 - Station address52
 - Steam pressure control.....39
 - Summer mode32
 - Summer time/winter time changeover 39
 - Sustained DHW temperature16
 - Switching states of binary inputs.....12
 - Systems.....24
- T**
- Technical data79
 - Temperature monitoring46
 - Temperature monitoring alarm.....46
 - Text message in case of error.....47
 - Three-step control.....42
 - Time-of-use10
- U**
- Unauthorized access occurred 45, 47, 50

Underfloor heating 29

V

Vacation periods..... 14

Valve positions 12

W

Weather-compensated control 25

S

start-up 18 - 22



**Key
number:**

1732



Key abbreviations

AF Outdoor sensor
AnI System
AT Outdoor temperature
BA Binary output
BE Binary input
CO Configuration level
CP Solar circuit pump
EB Mounting and operating

instructions

F Function block
GLT Building control station
KI Terminal
KW Cold water
PA Parameter level

RF Room sensor
Rk Control circuit
RÜF Return flow sensor
SF Storage tank sensor
SLP Storage tank charging pump
t Time
T Temperature
TLP Heat exchanger charging pump
TWE DHW heating
UP Circulation pump
VF Flow sensor
WE Default setting
WWHot water
ZP Circulation pump

 KOMFORT

 **SAUTER**

SAUTER Deutschland
Sauter-Cumulus GmbH
Hans-Bunte-Str. 15
79108 Freiburg

<http://www.sauter-cumulus.de>

Telefon +49 (761) 5105-0

Telefax +49 (761) 5105-234

E-Mail: sauter-cumulus@de.sauter-bc.com