

EQJW146F002

P100019103



Heating and District Heating Controller
with graphics display

Firmwareversion 2.4x



Old > New	Firmware revisions
2.3x > 2.4x	Connected sensor inputs not relevant for closed-loop control are displayed on the 'Special values' screen in the controller's operating level (see section 3.8)
	New functions and parameters for buffer tank systems (see section 6.5) <ul style="list-style-type: none"> – CO1 > F22: SLP depending on return flow temperature – CO5 > F25: AA1 reverse – CO5 > F31: AE1 zero shift – PA1 > P16: Minimum set point to charge buffer tank – PA1 > P17: Stop charging of the buffer tank – PA1 > P18: Charging temperature boost – PA1 > P19: Lag time of charging pump
	New differential temperature control function (CO1 > F23) in systems AnI 1.0 and 16.0 (see section 6.13)
	Restrictions when a mini module (order no. 1400-7436) is used (see section 10.3)



Note on these mounting and operating instructions

These mounting and operating instructions assist you in mounting and operating the device safely. The instructions are binding for handling SAUTER devices.

→ For the safe and proper use of these instructions, read them carefully and keep them for later reference.



Definition of signal words

DANGER

Hazardous situations which, if not avoided, will result in death or serious injury

WARNING

Hazardous situations which, if not avoided, could result in death or serious injury

NOTICE

Property damage message or malfunction

Note

Additional information

Tip

Recommended action

1	Safety instructions.....	8
1.1	Disposal.....	8
2	Operation	9
2.1	Operating controls.....	9
2.1.1	Rotary pushbutton.....	9
2.1.2	Rotary switch.....	9
2.2	Reading information	10
2.2.1	Adapting the Trend-Viewer.....	14
2.3	Selecting operating modes	16
2.4	Setting the time and date	17
2.5	Setting the times-of-use	19
2.6	Setting special times-of-use	21
2.6.1	Party timer.....	21
2.6.2	Public holidays.....	22
2.6.3	Vacations	24
2.7	Entering day and night set points	26
3	Start-up	28
3.1	Setting the system code number	29
3.2	Activating and deactivating functions	30
3.3	Changing parameters	32
3.4	Calibrating sensors.....	33
3.5	Altering the display contrast	35
3.6	Changing the display language	35
3.7	Loading default setting	35
3.8	Special values.....	36
4	Manual mode.....	37
5	Systems	38
6	Functions of the heating circuit	77
6.1	Outdoor-temperature-controlled control	77
6.1.1	Gradient characteristic	78
6.1.2	Four-point characteristic.....	80
6.2	Fixed set point control.....	81

6.3	Underfloor heating/drying of jointless floors	82
6.4	Outdoor temperature for rated operation (day)	83
6.5	Buffer tanks stems Anl 16.x.....	84
6.6	Summer mode.....	85
6.7	Delayed outdoor temperature adaptation	86
6.8	Remote Control Unit	87
6.9	Optimization	87
6.10	Flash adaptation	88
6.10.1	Flash adaptation without outdoor sensor (based on room temperature)	89
6.11	Adaptation	90
6.12	Cooling control.....	91
6.13	Differential temperature control.....	93
7	Functions of the DHW circuit	94
7.1	DHW heating in the storage tank system	94
7.1.1	DHW circuit additionally controlled by a globe valve.....	96
7.2	DHW heating in the storage tank charging system	97
7.2.1	Cold charging protection	99
7.3	DHW heating in instantaneous heating system.....	100
7.4	Domestic hot water heating with solar system.....	101
7.5	Intermediate heating	101
7.6	Parallel pump operation	102
7.7	Circulation pump during storage tank charging	102
7.8	Priority position.....	102
7.8.1	Reverse control.....	103
7.8.2	Set-back operation.....	103
7.9	Forced charging of DHW storage tank.....	104
7.10	Thermal disinfection of DHW storage tank.....	104
8	System-wide functions	106
8.1	Automatic summer/standard time switchover	106
8.2	Frost protection.....	106
8.3	Forced pump operation	107
8.4	Return flow temperature limitation.....	107

8.5	Condensate accumulation control.....	109
8.6	Three-step control.....	109
8.7	On/off control	110
8.8	Continuous control in control circuit RK1.....	110
8.9	Releasing a control circuit/controller with binary input	111
8.10	Speed control of the charging pump.....	111
8.11	External demand processing.....	112
8.12	Capacity limitation in RK1	113
8.13	Creep feed rate limitation with a binary input	115
8.14	Requesting a demand by issuing a 0 to 10 V signal.....	115
8.15	Connecting potentiometers for valve position input	115
8.16	Locking manual level	116
8.17	Locking the rotary switch.....	116
8.18	Feeder pump operation.....	116
8.19	External demand for heat due to insufficient heat supply.....	116
8.20	Entering customized key number	117
9	Operational faults.....	118
9.1	Error list	118
9.2	Sensor failure	118
9.3	Temperature monitoring	119
9.4	Error status register.....	119
10	Communication	121
10.1	Memory module	121
11	Installation	124
12	Electrical connection.....	126
13	Appendix.....	132
13.1	Function block lists	136
13.2	Parameter lists	148
13.3	Resistance values.....	154
13.4	Technical data.....	155
13.5	Customer setting.....	156

1 Safety instructions

For your own safety, follow these instructions concerning the mounting, start up and operation of the controller:

- The device is to be mounted, started up or operated only by trained and experienced personnel familiar with the product.
- For electrical installation, you are required to observe the relevant electrotechnical regulations of the country of use as well as the regulations of the local power suppliers. Make sure all electrical connections are installed by trained and experienced personnel! Before performing any such work on the controller, disconnect it from the power supply.
- The device is designed for use in low voltage installations. For wiring and maintenance, you are required to observe the relevant regulations concerning device safety and electromagnetic compatibility.

To avoid damage to any equipment, the following also applies:

- Proper shipping and storage are assumed.
- Before start-up, wait until the controller has reached the ambient temperature.

1.1 Disposal

Waste electrical and electronic equipment may still contain valuable substances. They may also, however, contain harmful substances which were necessary for them to function. For this reason, do not dispose of this kind of equipment together with your household waste. Select a suitable disposal method. Instead, dispose of your waste equipment by handing it over to a designated collection point for the recycling of waste electrical and electronic equipment.

2 Operation

The controller is ready for use with the default temperatures and operating schedules. On start-up, the current time and date need to be set at the controller (see section 2.4).

2.1 Operating controls

The operating controls are located in the front panel of the controller.

2.1.1 Rotary pushbutton

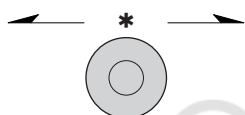

Rotary pushbutton

Turn [↻]:

Select readings, parameters and function blocks

Press [*]:

Confirm adjusted selection or settings

2.1.2 Rotary switch

The rotary switch is used to set the operating mode and the relevant parameters for each control circuit.

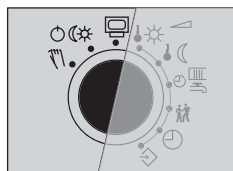

 Operating level

 Operating modes

 Manual level

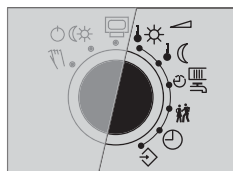

 Day set point (rated room temperature)

 Night set point (reduced room temperature)

 Times-of-use for heating/DHW

 Special time-of-use

 Time/date

 Settings

2.2 Reading information

The display indicates the date, time and actual temperature when the rotary switch is positioned at  (operating level).

Outdoor-temperature-compensated control · Current temperature = Outdoor temperature

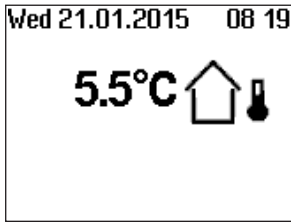

Deactivation depending on outdoor temperature active

A vacation period is active

Fixed set point control · Current temperature = Flow temperature

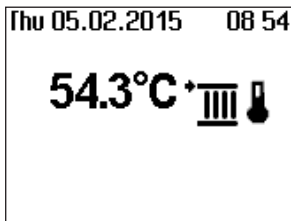

Further information can be obtained by turning the rotary pushbutton:

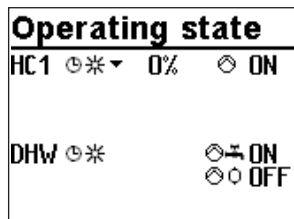

Operating state

The following applies for heating circuits HC1 and HC2:

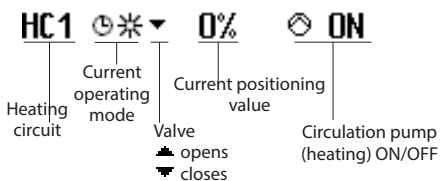

The following applies for DHW heating:

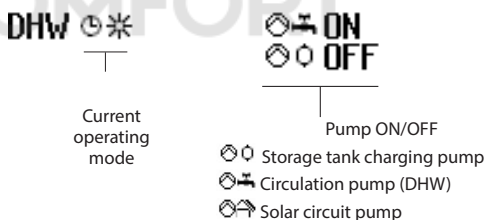

For further details, see section 2.3.

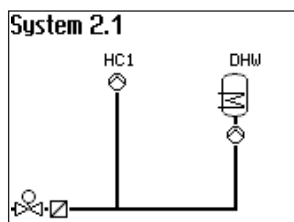

Selected system code number

For further details, see section 3.1.

- * Important measured values of the entire system, e.g. outdoor temperature, flow temperature and return flow temperature, are displayed.

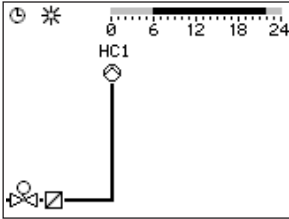

- ☺ Times-of-use (depending on system code number)
 - Heating circuit HC1
 - Heating circuit HC2
 - DHW heating

The day mode times is highlighted in black on the time chart.

Night mode and deactivation times are highlighted in gray on the time chart.

For further details, see section 2.5.

Sonderwerte	
0-10V Messw.	0.0
Messwert 2	28.2
Messwert 3	49.3
Messwert 4	57.3
Messwert 5	12.2

- ☺ Special values

Measured values from additional sensor inputs (not relevant for closed-loop control) or from the 0 to 10 V input are displayed.

Alarmliste	
19:59	HK1 Wartungshinw.
02.03.	Sensorausfall
23.02.	Temp.überwachung
10.02.	Desinfektion
07.03.2016 19:59 - HK1 Es	

- ☺ Alarm list

The last four alarm entries are listed.
- * Open the alarm list and select further alarm entries (☺).

Further information on an alarm (including time and date when it occurred) runs across the display.

Ereignisliste	
09:12	PA1-P01 = 1.3
09:12	C04-FB07=0
09:11	Anlage=2.1
09:10	Werkskaltstart
03.02.2016 09:12 - Paramet	

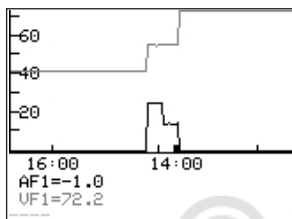

- ⌂ Event list
The last four event entries are listed.
- * Open the event list and select further event entries (⌂).
Further information on an event (including time and date when it occurred) runs across the display.
- ⌂ Trend-Viewer
The standard graph shows the data measured at the outdoor sensor AF1 and flow sensor VF1 plotted over time.
For further details, see section 2.2.1.

i Note

Details on the controller version (device identification, serial number, software and hardware versions) are displayed in the extended operating level.

Informationen	
Geraetekennung	5573
Seriennummer	2604
Softwareversion	2.03
Hardwareversion	1.33

Turn the rotary switch to  (settings).

- ⌂ Enter code number 1999.
- * Confirm key number.

Turn the rotary switch to  (operating level).

- ⌂ Select 'Information'.

Informationens. 1/3	
Modbus Station	1
Datalogging-Fs	AUS
Solarbetrieb	0 h
Durchfluss 1	0
Sonderflags	3840

Informationen S.2/3	
VF1-Rüf1	--.-°C
Y1 Mittel vMon	10240
Y1 Mittel lMon	0
Y1 Mittel aMon	0
Binäreingänge	□□□□□□□□

Informationen S.3/3	
Reset-Grund	0x00

The additional "meter" page is displayed with connection status and further meter data for meters 1 to 3 in the "extended operating level" mode when the meter bus is activated (see section 10.2.1). In addition, the respective measuring and limit values are displayed after confirming the plant scheme when the flow rate and/or capacity limitation is active.

i Note

- The additional information is hidden when the key number 1999 is entered again.
- The key number 1999 cannot be used to change the controller configuration and parameterization. A separate key number exists for configuration and parameterization (see section 3).

2.2.1 Adapting the Trend-Viewer

The standard graph shows the data measured at the outdoor sensor AF1 and flow sensor VF1 plotted over time.

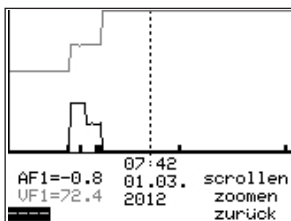

- * Open the Trend-Viewer.
- Adding measuring data
- ⌚ Select --- on the display.
 - * Activate editing mode for sensor selection.
 - ⌚ Select sensor.

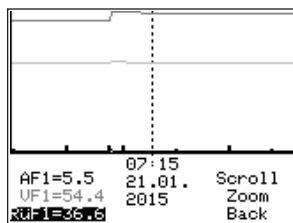

- * Confirm selected sensor.

Deleting measured data:

- ☞ Select the sensor whose measured data are no longer to be displayed.
- * Activate editing mode for sensor.
- ☞ Select ---- on the display.
- * Confirm deletion.

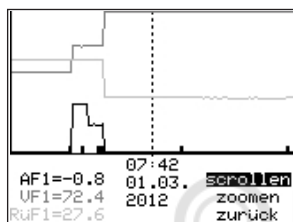

Shifting the time line:

- ☞ Select 'Scroll'.
- * Activate editing mode for scroll function.

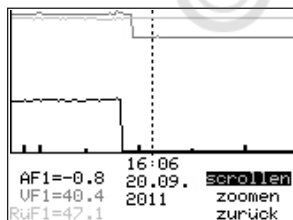

- ☞ Shift the time line.
- * Confirm time display.

Operation

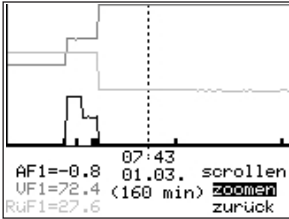

Zooming in/out

- ☪ Select 'Zoom'.
- * Open zoom function.
- ☪ Zoom in or out.

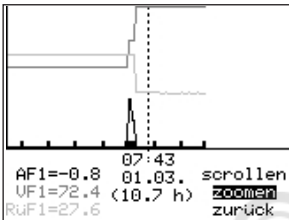

- * Confirm display.

Closing the Trend-Viewer

- ☪ Select 'Back'.
- * Close the Trend-Viewer



2.3 Selecting operating modes

Day mode (rated operation): regardless of the programmed times-of-use and summer mode, the set points relevant for rated operation are used by the controller. Icon: **

Night mode (reduced operation): regardless of the programmed times-of-use, the set points relevant for reduced operation are used by the controller. Icon:))

Control operation deactivated: regardless of the programmed times-of-use, control operation of the heating circuits and DHW heating remains deactivated. The frost protection is activated, if need be. Icon: ☺ ☺

Icons when the frost protection is activated: HC ☺) , DHW ☺ **

Automatic mode: during the programmed times-of-use, the controller works in day mode. Outside these times-of-use, the controller is in night mode, unless control operation is deactivated depending on the outdoor temperature. The controller switches automatically between both operating modes. Icon within the times-of-use: ☺ **, icon outside the times-of-use: ☺)

Manual mode: valves and pumps can be controlled manually. For further details, see section 4.

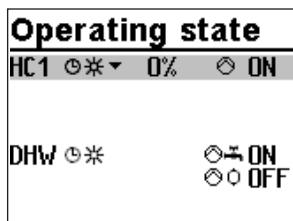

Turn the rotary switch to ☀️* (operating modes). The operating states of all system control circuits are displayed:

- Heating circuit HC1
- Heating circuit HC2
- DHW heating

➔ Only those control circuits are available for selection which can be controlled by the selected system.

⌚ Select the control circuit.

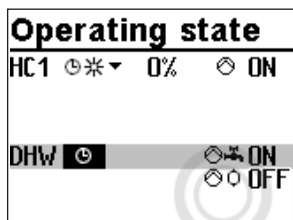

* Activate editing mode for the control circuit. The operating mode is shown inverted on the display.

⌚ Select the operating mode:

☀️ Automatic mode

* Day mode

🌙 Night mode

⏻ System deactivated

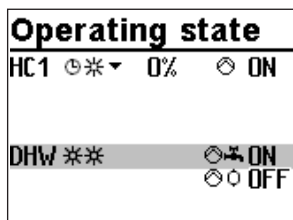

* Confirm the operating mode.

2.4 Setting the time and date

The current time and date need to be set immediately after start-up and after a power failure lasting more than 24 hours. This is the case when the time blinks on the display.

Time/date	
Time	08:23
Date (dd.mm.)	21.01.
Year	2015
Auto summertime	ON

Turn the rotary switch to \odot (time/date). The current time is selected (gray background).

Time/date	
Time	08:23
Date (dd.mm.)	21.01.
Year	2015
Auto summertime	ON

- * Activate editing mode for the time. The time reading is inverted.
- ⌚ Change the time.
- * Confirm the time setting.

Time/date	
Time	08:44
Date (dd.mm.)	21.01.
Year	2015
Auto summertime	ON

- ⌚ Select 'Date' (dd.mm) [⌚].

Time/date	
Time	08:44
Date (dd.mm.)	21.01.
Year	2015
Auto summertime	ON

- * Activate editing mode for the date. The date reading is inverted.
- ⌚ Change date (day.month).
- * Confirm the date setting.

Time/date	
Time	08:45
Date (dd.mm.)	05.02.
Year	2010
Auto summertime	ON

- ⌚ Select 'Year'.

Time/date	
Time	08:45
Date (dd.mm.)	05.02.
Year	2010
Auto summertime	ON

- * Activate editing mode for the year. The year reading is inverted.
- ↻ Change the year.
- * Confirm the year setting.

Deactivate or activate the automatic summer/standard time switchover as required. See section 8.1:

- ↻ Select 'Auto summertime'.

Time/date	
Time	08:45
Date (dd.mm.)	05.02.
Year	2015
Auto summertime	ON

- * Activate the editing mode for automatic summer/standard time switchover. The current setting is shown inverted on the display:
ON = Summer/standard time switchover active
OFF = Summer/standard time switchover not active

- ↻ Deactivate or activate the automatic summer/standard time switchover.

- * Confirm deactivation/activation.

Turn the rotary switch back to  (operating level).

Time/date	
Time	08:45
Date (dd.mm.)	05.02.
Year	2015
Auto summertime	ON

Note

The correct time is guaranteed after a power failure of 24 hours. Normally, the correct time is still retained at least 48 hours after a power failure.

2.5 Setting the times-of-use

Three times-of-use can be set for each day of the week.

Parameters	WE		Value range
	HC1, HC2	DHW, CP	
Start first time-of-use	06:00	00:00	00:00 to 24:00 h; in steps of 15 minutes
Stop first time-of-use	22:00	24:00	00:00 to 24:00 h; in steps of 15 minutes
Start second time-of-use	--:--	--:--	00:00 to 24:00 h; in steps of 15 minutes
Stop second time-of-use	--:--	--:--	00:00 to 24:00 h; in steps of 15 minutes

Operation

Start third time-of-use	--:--	--:--	00:00 to 24:00 h; in steps of 15 minutes
Stop third time-of-use	--:--	--:--	00:00 to 24:00 h; in steps of 15 minutes

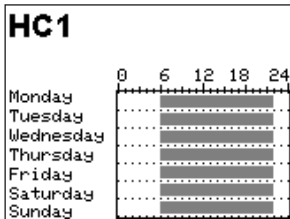

Turn the rotary switch to  (times-of-use). The first control circuit is displayed together with its programmed times-of-use.

- ⌚ Program the times-of-use of another control circuit, if required:
 - Heating circuit HC2
 - DHW heating
 - Circulation pump (DHW) CP
- ➔ Only those control circuits are available for selection which can be controlled by the selected system.

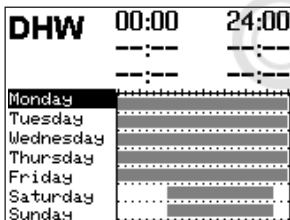

- * Activate editing mode for the control circuit. The times-of-use for Monday are displayed.

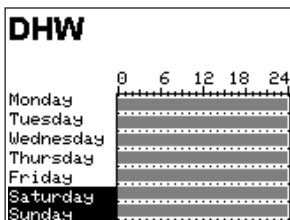

- ⌚ Select period/day for which the times-of-use are to be valid. The times-of-use can be programmed for individual days or for a block of days, e.g. Monday to Friday, Saturday and Sunday or Monday to Sunday. The selected days are shown inverted on the display.

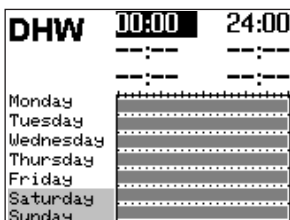

- * Activate editing mode for the period/day. The start time of the first time-of-use period can now be edited (inverted reading).

- ⌚ Change start time.(in steps of 15 minutes)
- * Confirm the start time.The stop time of the first time-of-use period can now be edited.
- ⌚ End stop time.(in steps of 15 minutes)

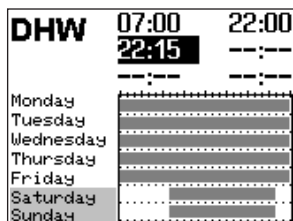

- * Confirm the stop time. The start time of the second time-of-use period can now be edited.

To set the second and third times-of-use periods, repeat steps with gray background. If no further times-of-use are to be programmed for the selected time period/day, exit the menu by confirming the indicated start time twice (2x *).

Proceed in the same manner to program further periods/days.

After setting all times-of-use:

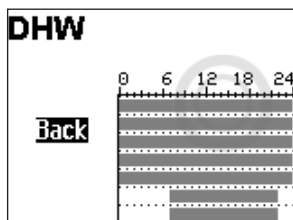

- ⏪ Select 'Back'.
- * Exit the times-of-use setting.

Turn the rotary switch back to  (operating level).

Note

All function block settings are saved in a non-volatile memory.

2.6 Setting special times-of-use

2.6.1 Party timer

Rated operating in the corresponding control circuit (HC1, HC2 or DHW) is started or continued for the time period set in the party timer. When the party timer has elapsed, the party timer returns to ---.

Parameters	WE	Value range
HC1 party timer	--- h	0 to 48 h; in steps of 15 minutes
HC2 party timer	--- h	0 to 48 h; in steps of 15 minutes
DHW party timer	--- h	0 to 48 h; in steps of 15 minutes

Special use	
HC1 Party timer	--:-- h
DHW Party timer	--:-- h
Public holidays	----
Vacations	---.---.---.---

Special use	
HC1 Party timer	--:-- h
DHW Party timer	--:-- h
Public holidays	----
Vacations	---.---.---.---

Special use	
HC1 Party timer	02:00 h
DHW Party timer	--:-- h
Public holidays	----
Vacations	---.---.---.---

Turn the rotary switch to **⌘** (special times-of-use). The party timer for the first control circuit is now selected.

- ⌚ Set party timer of another control circuit, if required:
 - Heating circuit HC2
 - DHW heating

➔ Only those control circuits are available for selection which can be controlled by the selected system.

* Activate editing mode for the party timer. The party timer is now in the editing mode (inverted display).

- ⌚ Extend day operation as required. (in steps of 15 minutes)

* Confirm setting.

After setting the party timer:

Turn the rotary switch back to **⊞** (operating level).

i Note

Party timer runs down in steps of 15 minutes.

2.6.2 Public holidays

On public holidays, the times-of-use specified for Sunday apply.

A maximum of 20 public holidays may be entered.

Parameters	WE	Value range
Public holidays	--:--	01.01 to 31.12

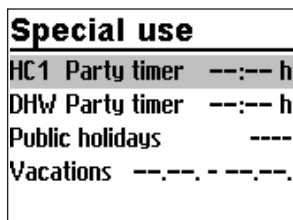

Turn the rotary switch to **h** (special times-of-use). The party timer for the first control circuit is now selected.

- ⌚ Select 'Public holidays'.

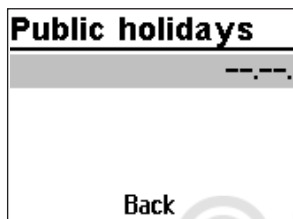

- * Start the public holiday setting. The first public holiday setting is now selected. ---:-- is displayed if no public holidays (default setting) have been programmed.

- ⌚ Select ---:--, if applicable.

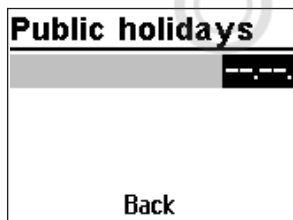

- * Activate editing mode for public holidays.

- ⌚ Set the date of the public holiday.

- * Confirm the date.

Proceed in the same manner to program further public holidays.

Deleting a public holiday:

- ⌚ Select the holiday you wish to delete.

- * Confirm the date.

- ⌚ Select ---:--.

- * Confirm setting.

The public holiday is deleted.

After programming all public holidays:

- ⌚ Select 'Back'.

- * Exit the public holiday setting.

Turn the rotary switch back to **□** (operating level).

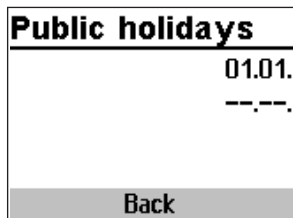

i Note

Public holidays that are not assigned to a specific date should be deleted by the end of the year so that they are not carried on into the following year.

2.6.3 Vacations

The system runs constantly in reduced mode during vacation periods. A maximum of ten vacation periods can be entered. Each vacation period can be separately assigned to the heating circuits HC1, HC2 and DHW circuit or to all control circuits.

Parameters	WE	Value range
Vacation period	--.--.--	01.01 to 31.12

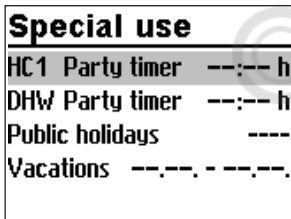

Turn the rotary switch to **#** (special times-of-use). The party timer for the first control circuit is now selected.

- ⌚ Select 'Vacations'.

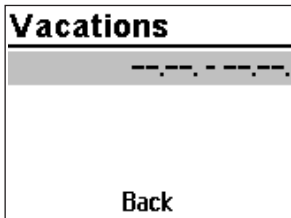

- * Start the vacations setting. The first vacations setting is now selected. --.--.-- is displayed if no vacations (default setting) have been programmed.
- ⌚ Select --.--.--, if applicable.

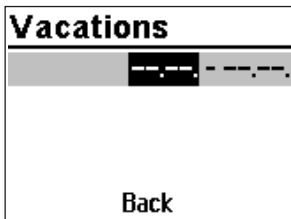

- ⌚ Activate editing mode for vacations.
The start date can now be edited (inverted reading).
- ⌚ Set the start date.
- ⌚ Confirm the start date.
The end date can now be edited.
- ⌚ Set the end date.

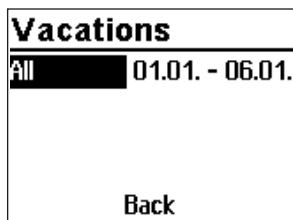

- ⌚ Confirm the year setting. 'All' is selected. The vacation period then applies to all control circuits.
- ⌚ If the vacation period is to be only valid for one control circuit, select the required control circuit:
 - Heating circuit HC1
 - Heating circuit HC2
 - DHW heating
- ➔ Only those control circuits are available for selection which can be controlled by the selected system.
- * Confirm the control circuit.

i Note

The  icon indicates that a vacation period is active.

Proceed in the same manner to program further vacations.

Deleting vacation periods:

- ⌚ Select the start date of the period you wish to delete.
 - * Confirm vacation period.
 - ⌚ Select --.--- --.---
 - * Confirm setting.
- The vacation period is deleted.

After programming all vacation periods:

- ⌚ Select 'Back'.
- * Exit the vacations setting.

Turn the rotary switch back to  (operating level).

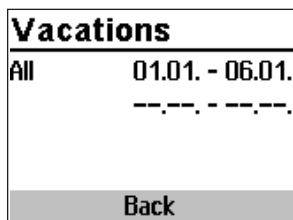

i Note

Vacations should be deleted by the end of the year so that they are not carried on into the following year.

2.7 Entering day and night set points

The desired room temperature for the day and night set points can be programmed.

Switch position $\downarrow\star$

Parameters	WE	Value range
HC1 room temperature	20.0 °C	0.0 to 40.0 °C
HC2 room temperature	20.0 °C	0.0 to 40.0 °C
DHW temperature	60.0 °C	Min. to max. DHW temperature
HC1 OT deactivation value	22.0 °C	0.0 to 50.0 °C
HC2 OT deactivation value	22.0 °C	0.0 to 50.0 °C

Switch position $\downarrow\llcorner$

Parameters	WE	Value range
HC1 room temperature	15,0 °C	0.0 to 40.0 °C
HC2 room temperature	15,0 °C	0.0 to 40.0 °C
DHW temperature	40.0 °C	Min. to max. DHW temperature
HC1 OT deactivation value	15,0 °C	-50.0 to 50.0 °C
HC2 OT deactivation value	15,0 °C	-50.0 to 50.0 °C

Night set points	
HC1 Room temp.	15.0°C
DHW DHW temp.	40.0°C
HC1 OT deac. day	15.0°C

Turn the rotary switch to $\downarrow\star$ (day set point) or $\downarrow\llcorner$ (night set point).

The day or night set points are listed on the display.

➔ Only those day and night set points are available for selection which can be controlled by the selected system.

i Note

The deactivation values are located in a separate menu (deactivation values) for systems with three control circuits.

⌚ Select the set point.

Night set points		
HC1	Room temp.	15.0°C
DHW	DHW temp.	40.0°C
HC1	OT deac. da	15.0°C

* Activate editing mode for set point.

↻ Adjust the set point.

* Confirm setting.

Proceed in the same manner to adjust further set points.

After adjusting all the set points:

Turn the rotary switch back to  (operating level).



3 Start-up

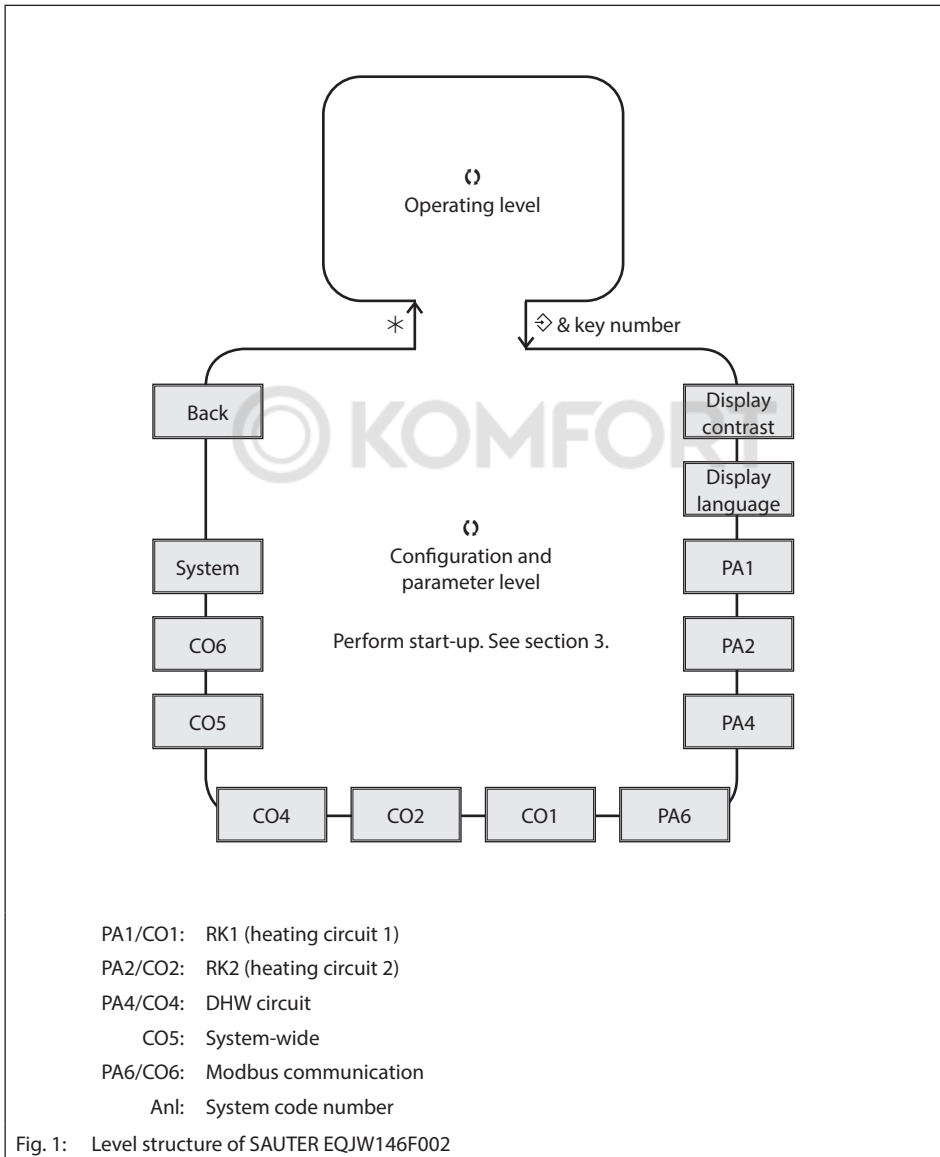

The modifications of the controller configuration and parameter settings described in this section can only be performed after the valid key number has been entered.

The key number that is valid on the first start-up can be found on page 165. To avoid unauthorized use of the service key number, remove the page or make the key number unreadable. In addition, it is possible to enter a new, customized key number (see section 8.20).

3.1 Setting the system code number

31 different hydraulic schematics are available. Each system configuration is represented by a system code number. The different schematics are dealt with in section 5. Available controller functions are described in sections 6, 7 and 8.

Changing the system code number resets previously adjusted function blocks to their default settings (WE). Function block parameters and parameter level settings remain unchanged.

The system code number is set in the configuration and parameter level.

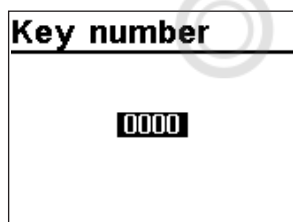

Turn the rotary switch to \diamond (settings).

- ◁ Enter the currently valid key number.
- * Confirm key number.

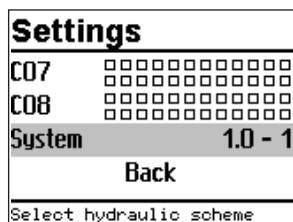

- ◁ Select 'System'.
- * Open 'System'.

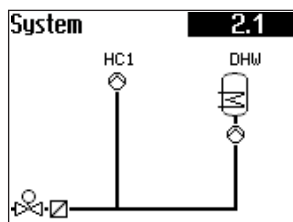

- ◁ Select the required system.

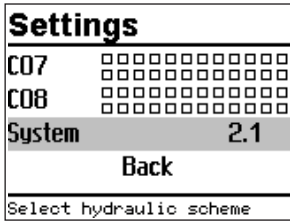

- * Confirm the system selected.
 - ↻ Select 'Back'.
 - * Exit menu.
- Turn the rotary switch to ↻ (settings).

3.2 Activating and deactivating functions

A function is activated or deactivated in the associated function block. For more details on function blocks, see section 13.1.

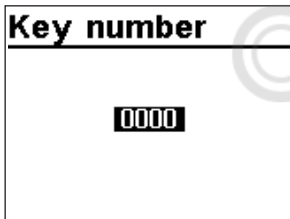

- Turn the rotary switch to ↻ (settings).
- ↻ Enter the currently valid key number.
- * Confirm key number.

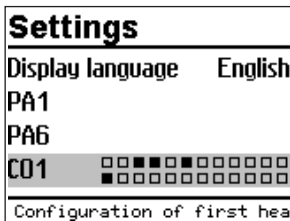

- ↻ Select the required configuration level:
 - CO1: Heating circuit HC1
 - CO2: Heating circuit HC2
 - CO3: Not applicable
 - CO4: DHW heating
 - CO5: System-wide functions
 - CO6: Modbus communication

Active function blocks are indicated by the black squares.

- ➔ Only those configuration levels are available for selection which can be controlled by the selected system.

CO1	□□■□□□□□□□
F01 Room sensor	0
F02 Outdoor sensor	1
F03 Return flow sensor	1
F04 Cooling control	0
Room sensor RF1	

CO1	□□■□□□□□□□
F05 Underfloor heating	
F05	1
Start temperature	25.0°C
Temp. rise/date	5.0°C
jointless floors	Under

CO1	□□■□□■□□□□
F17 Binary demand	0
F18 Requesting demand	0
F20 Ext. heat demand	0
Back	
Exit menu	

- * Open configuration level.
The first function block is selected (marked gray).

☪ Select function.

Functions without function block parameters:

- * Activate editing mode for the function.
The currently active configuration '0' or '1' is shown inverted on the display.
- ☪ Activate function (1) or deactivate function (0).
- * Confirm configuration.

Functions with function block parameters:

- * Open function.
- ☪ Select configuration.
- * Activate editing mode for configuration.
The currently active configuration '0' or '1' is shown inverted on the display.
- ☪ Activate function (1) or deactivate function (0).
- * Confirm configuration.
- ☪ Select function block parameter.
- * Activate editing mode for function block parameter.
The current setting is shown inverted on the display.
- ☪ Set function block parameter.

Proceed in the same manner to set further function blocks.

Exit configuration level:

- ☪ Select 'Back'.
- ☪ Exit configuration level.

To adjust further function blocks in other configuration levels, repeat steps with gray background.

Turn the rotary switch back to  (operating level).

3.3 Changing parameters

Depending on the system code number selected and the activated functions, not all parameters listed in section 13.2 might be available.

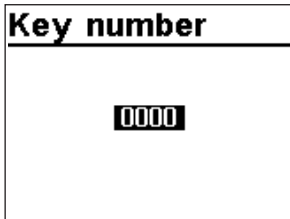

Turn the rotary switch to  (settings).

- ⌂ Enter the currently valid key number.
- * Confirm key number.

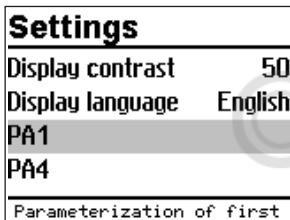

- ⌂ Select the required parameter level:
 - PA1: Heating circuit HC1
 - PA2: Heating circuit HC2
 - PA3: Not applicable
 - PA4: DHW heating
 - PA5: Not applicable
 - PA6: Modbus communication

➔ Only those parameter levels are available for selection which can be controlled by the selected system.

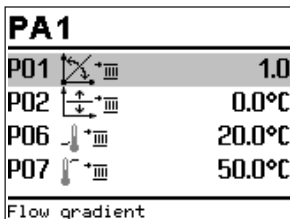

- * Open parameter level.
The first parameter is selected (marked gray).

- ⌂ Select parameter.
- * Activate editing mode for the parameter.
The current setting is shown inverted on the display.
- ⌂ Set the parameter.
- * Confirm setting.
- * Proceed in the same manner to change further parameters.

PA 1	
P12	0.0°C
P13	65.0°C
P14	65.0°C
Back	
Exit menu	

Exit parameter level.

↻ Select 'Back'.

↻ Exit configuration level.

To adjust further function blocks in other configuration levels, repeat steps with gray background.

Turn the rotary switch back to  (operating level).

i Note

All parameter settings are saved in a non-volatile memory.

3.4 Calibrating sensors

The controller is designed for connection of Pt 1000, PTC and Ni 1000 sensors.

- CO5 > F01 - 1, F02 - 0: Pt 1000
- CO5 > F01 - 0, F02 - 0: PTC
- CO5 > F01 - 1, F02 - 1: Ni 1000

The resistance values are listed on page 148.

If the temperature values displayed at the controller differ from the actual temperatures, the measured values of all connected sensors can be recalibrated. To calibrate a sensor, the currently displayed sensor value must be changed such that it matches the temperature (reference temperature) measured directly at the point of measurement. Sensor calibration is activated in CO5 in F20 function block.

An incorrect sensor calibration can be deleted by setting F20 - 0.

Key number
0000

Turn the rotary switch to  (settings).

↻ Enter the currently valid key number.

* Confirm key number.

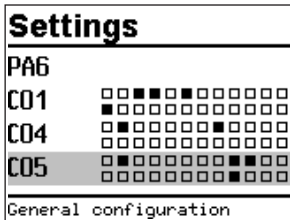

- * Select CO5 configuration level.
- * Open CO5 configuration level.
- * Select F20 function block.
- * Activate editing mode for F20 function block.

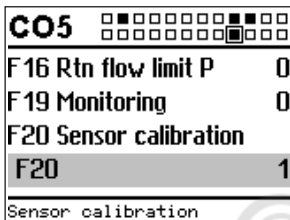

- ⌂ Select F20 configuration.
- * Activate editing mode for configuration.
The currently active configuration '0' or '1' is shown inverted on the display.
- ⌂ Activate function block ('1').
- * Confirm activation.

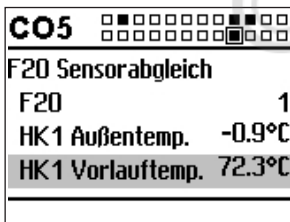

- * Select the temperature that you want to calibrate.
- * Open calibration.
The temperature is shown inverted on the display.
- * Correct measured value.
Read the actual temperature directly from the thermometer at the point of measurement and enter this value as the reference temperature.
- * Confirm corrected measured value.
- * Proceed in the same manner to calibrate further sensors.

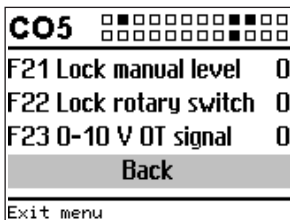

- Exit configuration level:
- ⌂ Select 'Back'.
 - ⌂ Exit configuration level.
- Turn the rotary switch back to (operating level).

3.5 Altering the display contrast

You can alter the contrast of the display.

Settings	
Display contrast	50
Display language	English
PA1	
PA4	
Contrast setting of display	

Turn the rotary switch to  (settings).

 Enter the currently valid key number.

* Confirm key number.

 Select 'Display contrast'.

* Activate editing mode for the display contrast.

The current setting is shown inverted on the display.

 Set the display contrast

* Confirm setting.

Turn the rotary switch back to  (operating level).

3.6 Changing the display language

The default display language is German. The setting can be changed to English.

Settings	
Display contrast	50
Display language	English
PA1	
PA4	
Open display language menu	

Turn the rotary switch to  (settings).

 Enter the currently valid key number.

* Confirm key number.

 Select 'Display language'.

* Activate editing mode for the language setting.

The currently valid language is selected.

 Change language setting.

* Confirm setting.

Turn the rotary switch back to  (operating level).

3.7 Loading default setting

All parameters set over the rotary switch as well as parameters in the PA1 and PA2 parameter levels can be reset to their default settings (WE), except for the maximum flow temperature and the return flow temperature limits in PA1 and PA2.

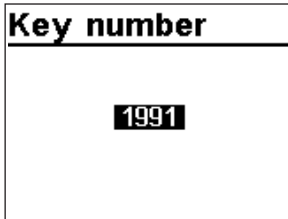

Turn the rotary switch to  (settings).

 Enter key number 1991.

* Confirm key number.

The settings are reset when the following icon appears on the controller display:



3.8 Special values

Sonderwerte	
0-10V Messw.	0.0
Messwert 2	28.2
Messwert 3	49.3
Messwert 4	57.3
Messwert 5	12.2

If sensor inputs not relevant for closed-loop control are connected, the 'Special values' screen is automatically displayed in the controller's operating level. A maximum of five measured values (sensor inputs or 0 to 10 V input) can be displayed. These readings are displayed without a unit. '°C' is the unit for all sensor inputs. The value originating from the 0 to 10 V input with the CO -> F25-1 setting is displayed as a percentage.

i Note

The measured value number corresponds to the terminal number, e.g. measured value 3 = terminal 3

4 Manual mode

Switch to manual mode to configure all outputs (see section 12).







NOTICE

System damage caused by frost when manual operating mode is active!

The frost protection function is deactivated in the manual operating mode.

Do not run the heating during cold weather in the manual mode for long periods of time.

Manually changing the positioning value/switching state:

Manual mode			
HC1			0%
HC1			ON
DHW			ON
DHW			OFF
Information			

Turn the rotary switch to  (manual mode).

The outputs of the configured system are listed on the display.

① Select the output

 Positioning value

 Circulation pump (heating)

 Storage tank charging pump

 Circulation pump (DHW)

 Solar circuit pump

② Activate editing mode for the output.

③ Change the positioning value/switching state.

④ Confirm the positioning value/switching state.

The modified values remain active as long as the controller is in manual mode.

Turn the rotary switch to  (operating level). The manual mode is deactivated.

Note

The outputs of the controller are not affected by merely turning the rotary switch to  (manual mode). The outputs are only changed by entering or changing the positioning values or switching states.

5 Systems

Different hydraulic schematics are available. The system images on the display show the structure of the hydraulic system.

Boiler systems:

Single-stage boiler systems can be configured from any system whose heating circuits and DHW circuit include just one heat exchanger. These systems are An1 1.0-1, 1.5-1, 1.6-1, 1.6-2, 1.9-1, 1.9-2, 2.x, 3.0, 3.5, 4.0, 4.1 and 16.x.

The boiler can be controlled by an on/off output (CO1 > F12 - 0).

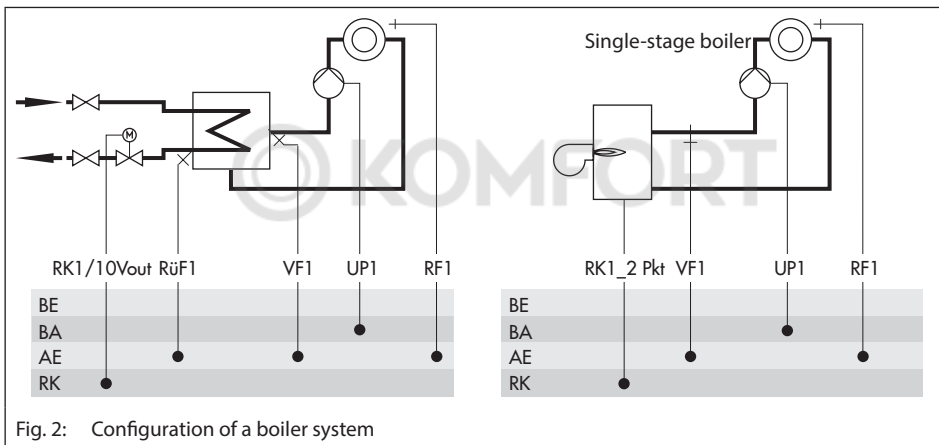

System Anl 1.0-1

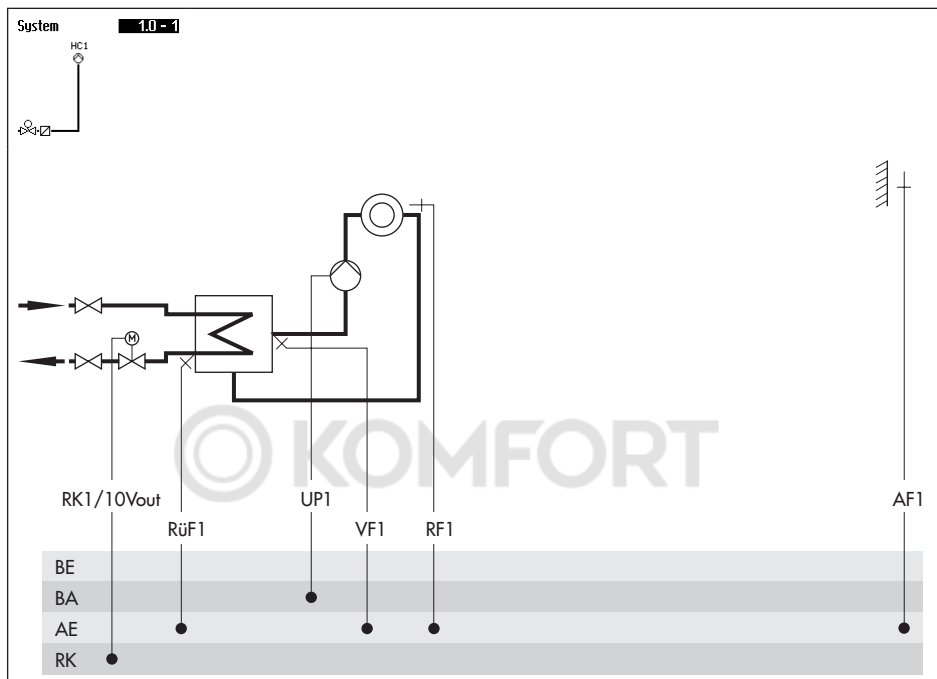

Default settings

CO1 > F01	- 0 (without RF1)
CO1 > F02	- 1 (with AF1)
CO1 > F03	- 1 (with RüF1)
CO5 > F07	- 0 (without error message at terminal 29)

System Anl 1.0-2

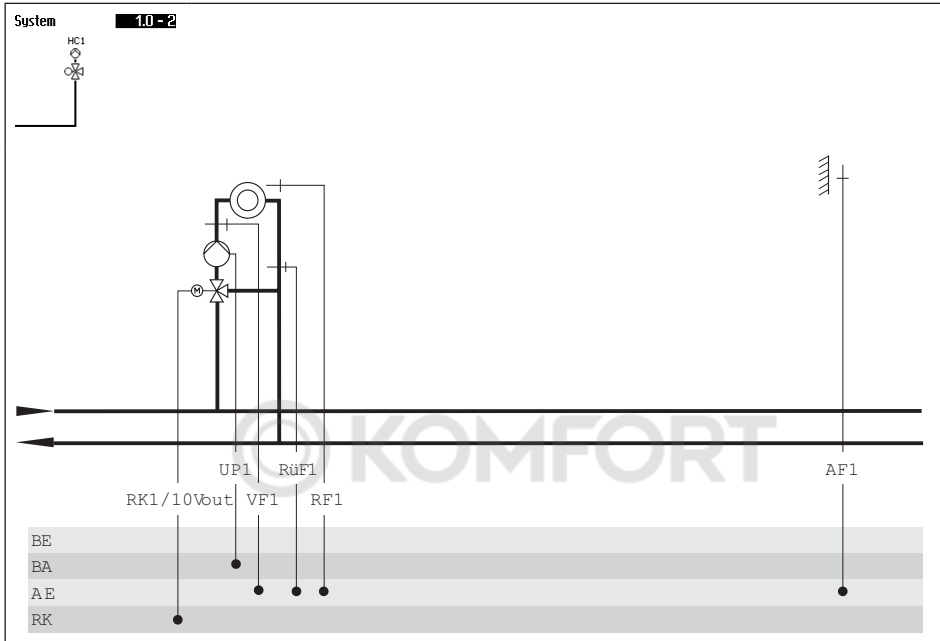

Default settings	
CO1 > F01	- 0 (without RF1)
CO1 > F02	- 1 (with AF1)
CO1 > F03	- 1 (with RüF1)
CO5 > F07	- 0 (without error message at terminal 29)

System Anl 1.1-1

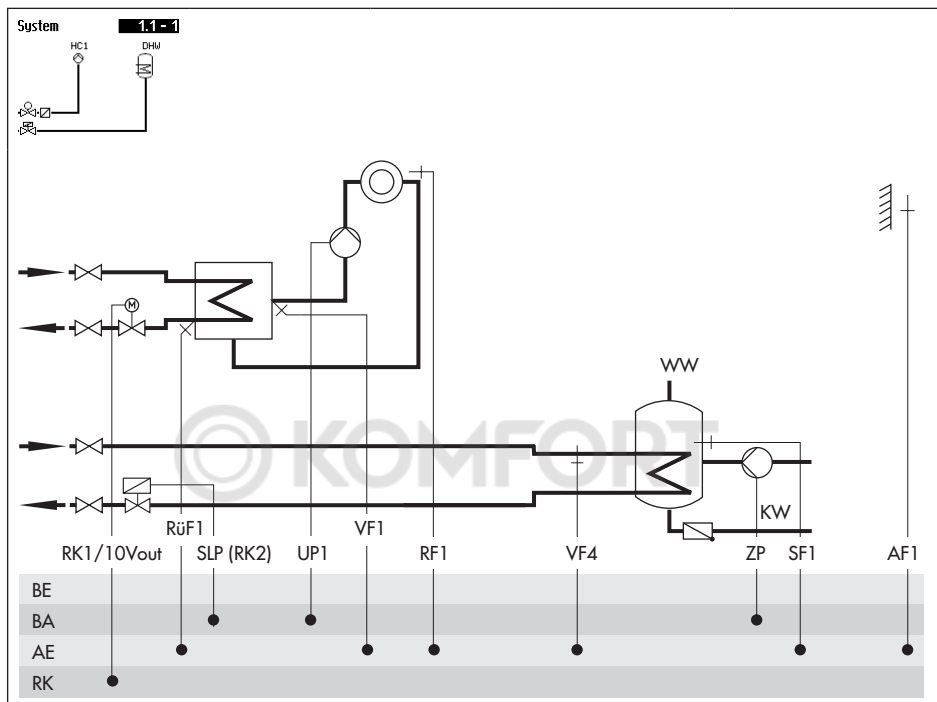

Default settings	
CO1 > F01	- 0 (without RF1)
CO1 > F02	- 1 (with AF1)
CO1 > F03	- 1 (with RüF1)
CO4 > F01	- 1 (with SF1)
CO4 > F02	- 0 (without SF2)
CO4 > F05	- 0 (without VF4)
CO5 > F07	- 0 (without error message at terminal 29)

System Anl 1.1-2

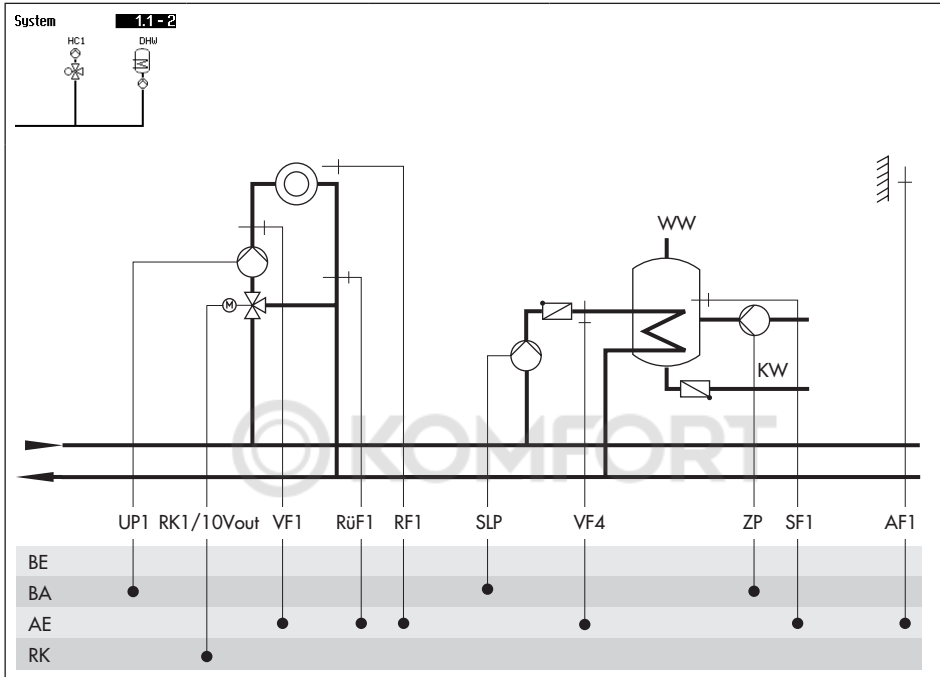

Default settings	
CO1 > F01	- 0 (without RF1)
CO1 > F02	- 1 (with AF1)
CO1 > F03	- 1 (with RüF1)
CO4 > F01	- 1 (with SF1)
CO4 > F02	- 0 (without SF2)
CO4 > F05	- 0 (without VF4)
CO5 > F07	- 0 (without error message at terminal 29)

System Anl 1.2

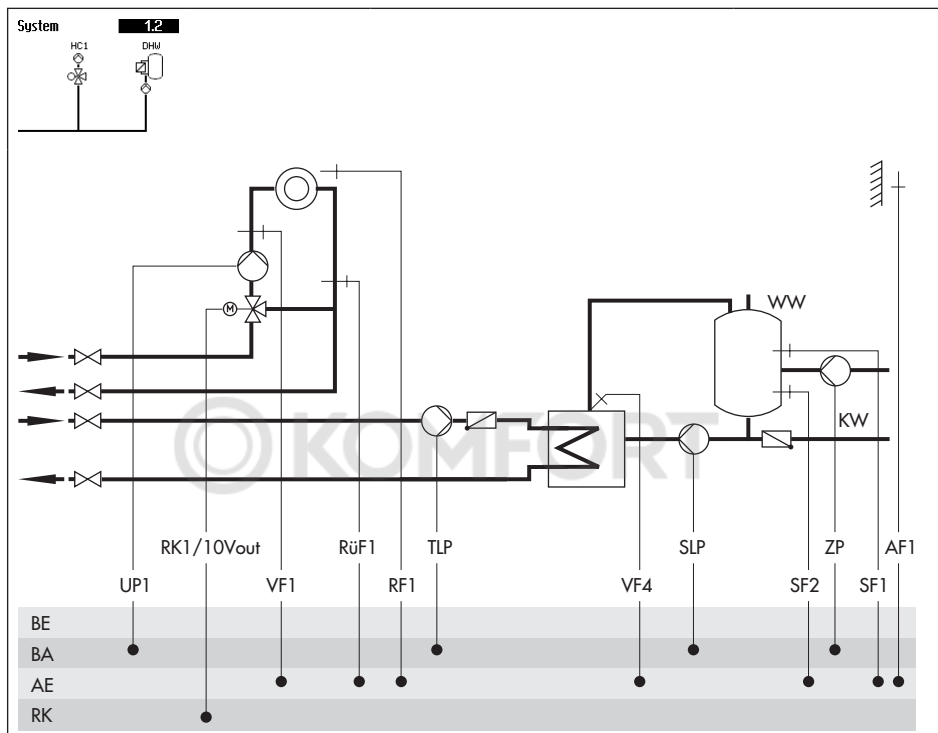

Default settings	
CO1 > F01	- 0 (without RF1)
CO1 > F02	- 1 (with AF1)
CO1 > F03	- 0 (without RüF1)
CO4 > F01	- 1 (with SF1)
CO4 > F02	- 1 (with SF2)
CO4 > F05	- 0 (without VF4)
CO5 > F07	- 0 (without error message at terminal 29)

System Anl 1.3-1

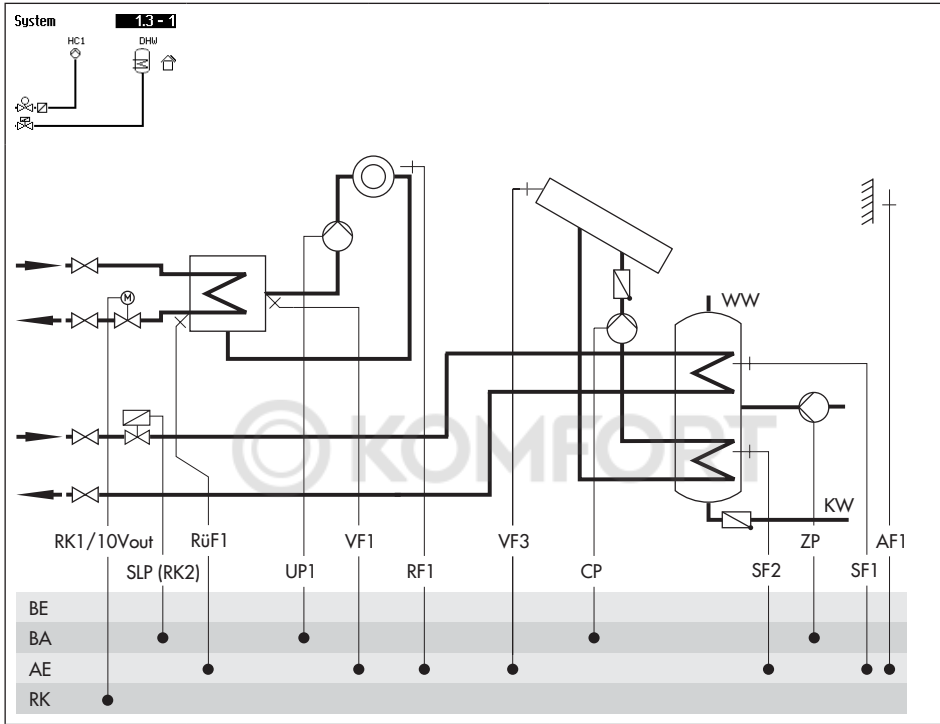

Default settings	
CO1 > F01	- 0 (without RF1)
CO1 > F02	- 1 (with AF1)
CO1 > F03	- 1 (with RüF1)
CO4 > F01	- 1 (with SF1)
CO5 > F07	- 0 (without error message at terminal 29)

System Anl 1.3-2

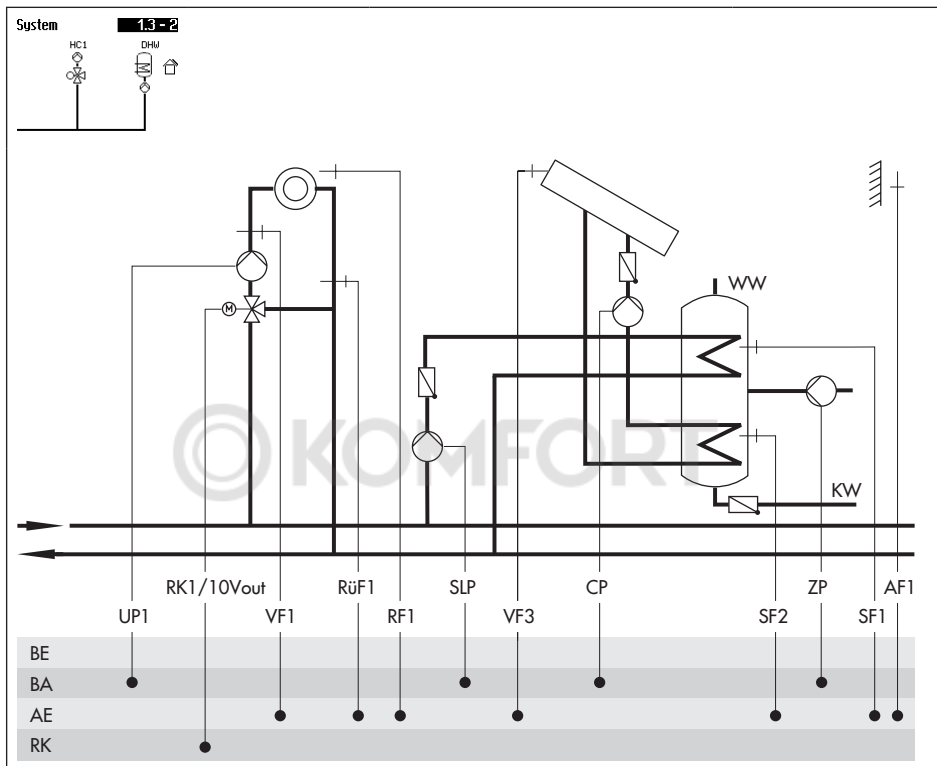

Default settings	
CO1 > F01	- 0 (without RF1)
CO1 > F02	- 1 (with AF1)
CO1 > F03	- 1 (with RüF1)
CO4 > F01	- 1 (with SF1)
CO5 > F07	- 0 (without error message at terminal 29)

System Anl 1.5-1

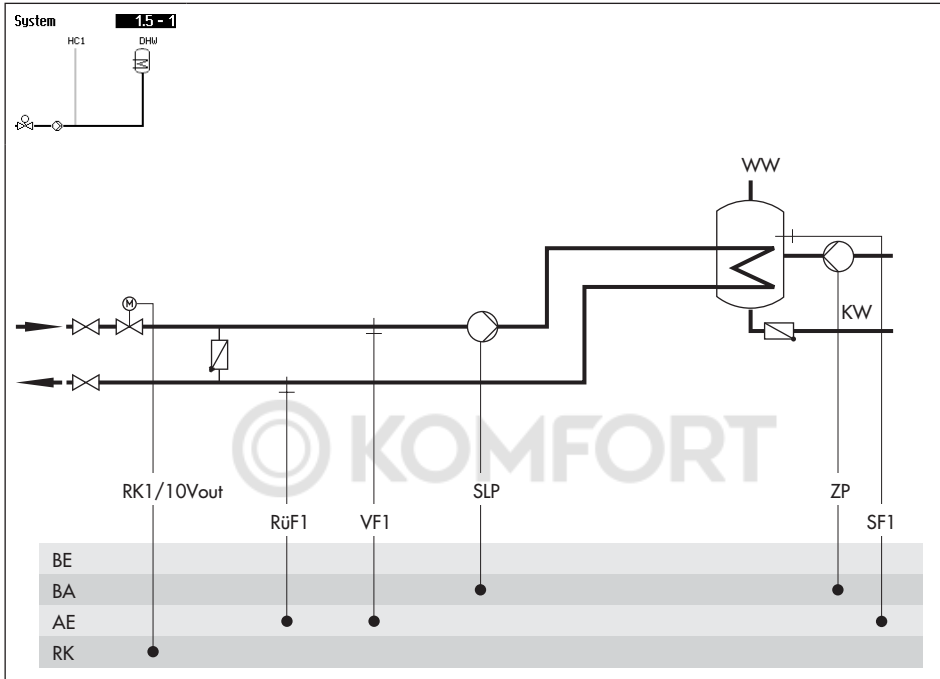

Default settings	
CO1 > F03	- 1 (with RüF1)
CO4 > F01	- 1 (with SF1)
CO4 > F02	- 0 (without SF2)
CO5 > F07	- 0 (without error message at terminal 29)

System Anl 1.5-2

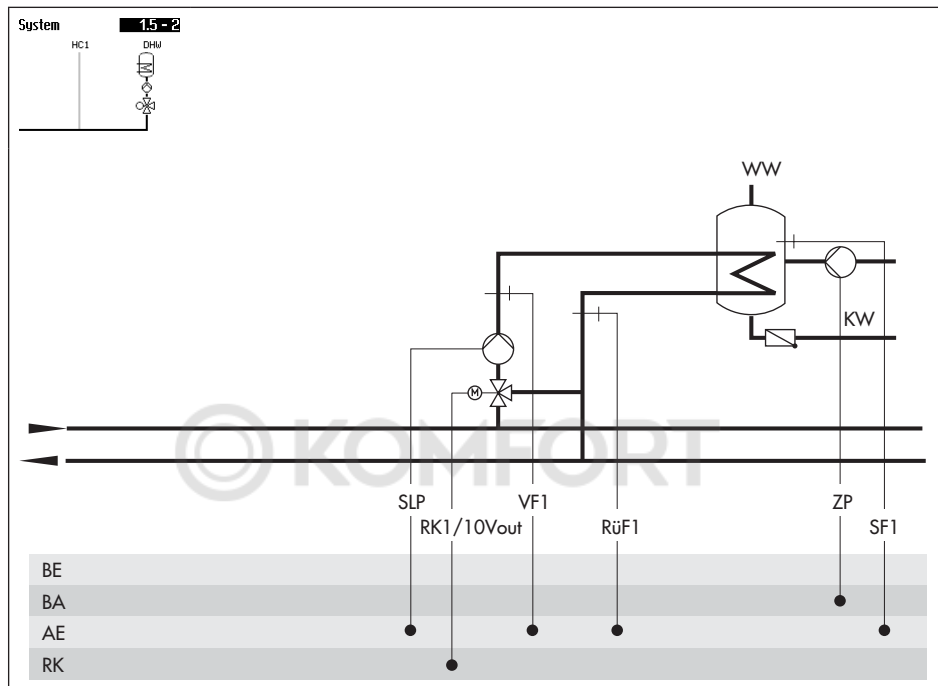

Default settings

CO1 > F03	- 1 (with RüF1)
CO4 > F01	- 1 (with SF1)
CO4 > F02	- 0 (without SF2)
CO5 > F07	- 0 (without error message at terminal 29)

System Anl 1.6-1

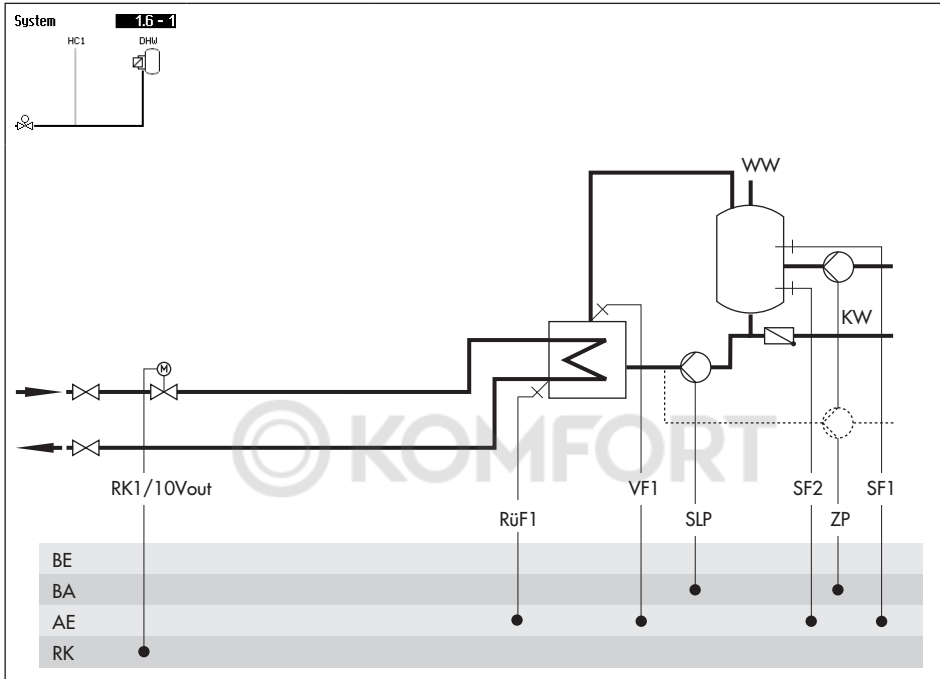

Default settings	
CO1 > F03	- 1 (with RüF1)
CO4 > F01	- 1 (with SF1)
CO4 > F02	- 1 (with SF2)
CO5 > F07	- 0 (without error message at terminal 29)

System Anl 1.6-2

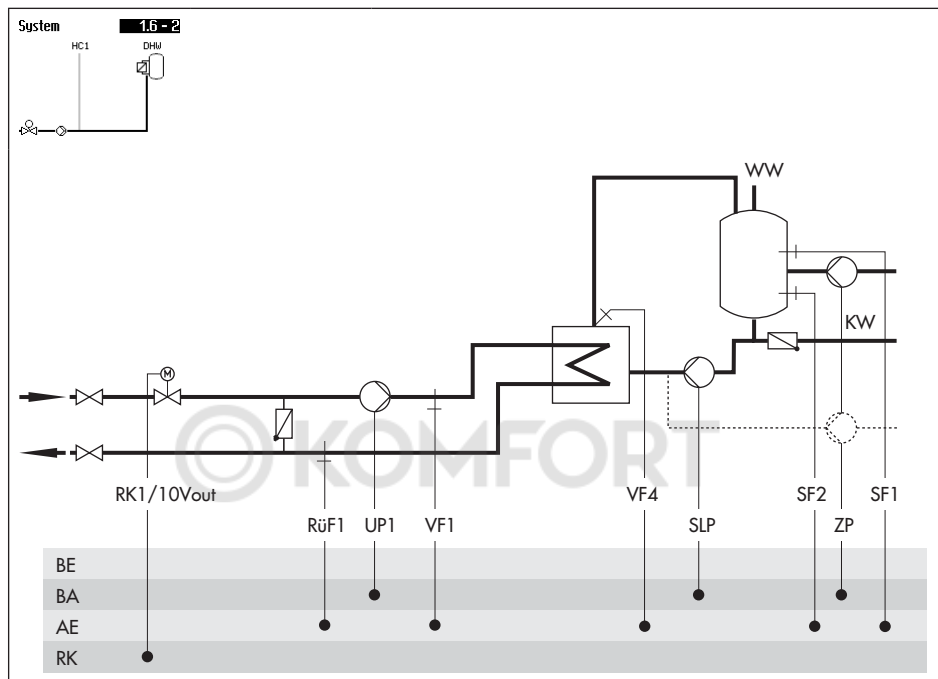

Default settings	
CO1 > F03	- 1 (with RüF1)
CO4 > F01	- 1 (with SF1)
CO4 > F02	- 1 (with SF2)
CO4 > F05	- 0 (without VF4)
CO5 > F07	- 0 (without error message at terminal 29)

System Anl 1.6-3

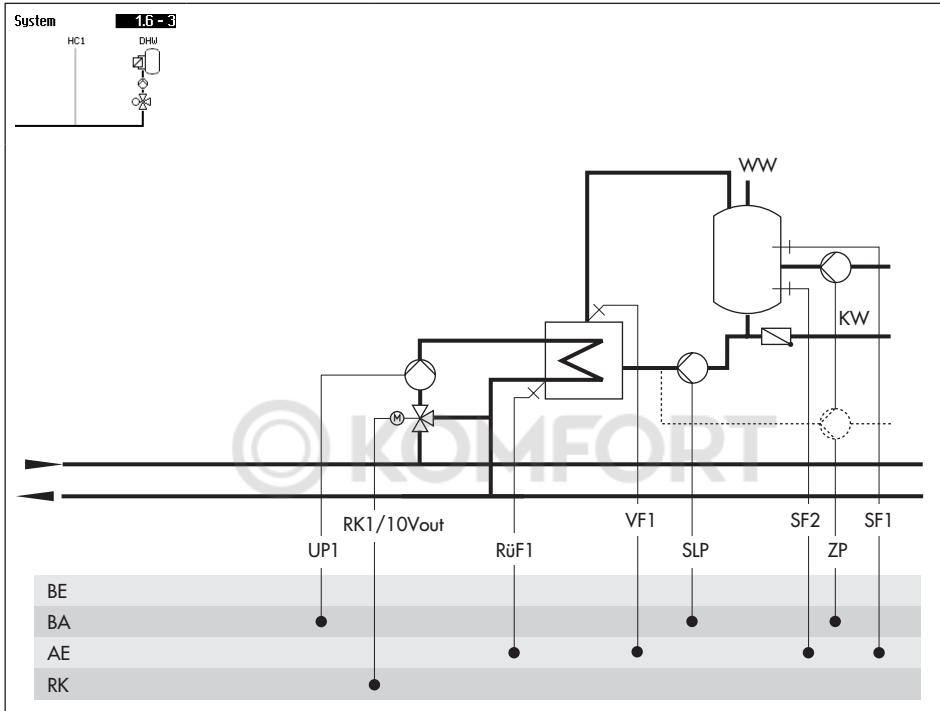

Default settings	
CO1 > F03	- 1 (with RüF1)
CO4 > F01	- 1 (with SF1)
CO4 > F02	- 1 (with SF2)
CO4 > F05	- 0 (without VF4)
CO5 > F07	- 0 (without error message at terminal 29)

System Anl 1.9

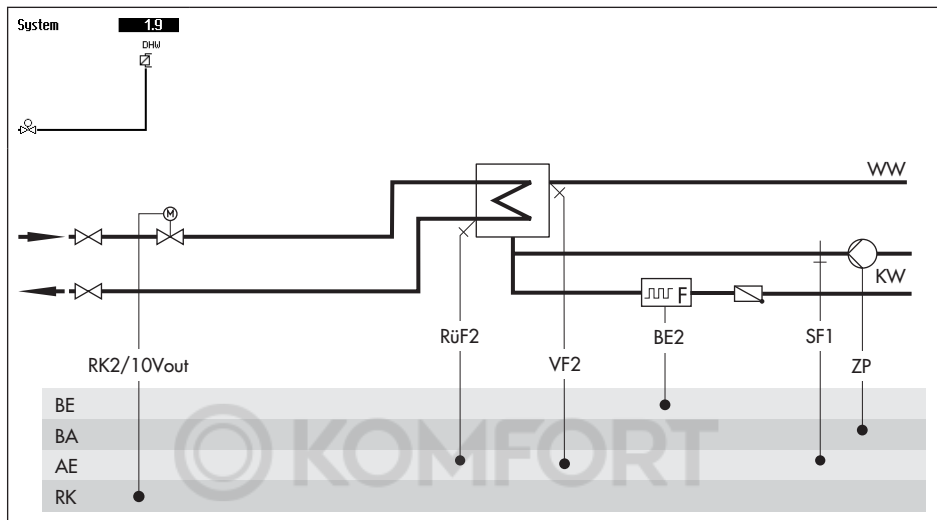

Default settings

CO4 > F01	- 0 (without SF1)
CO4 > F03	- 0 (without RüF2)
CO4 > F04	- 0 (without flow rate sensor)
CO5 > F07	- 0 (without error message at terminal 23)

System Anl 2.0

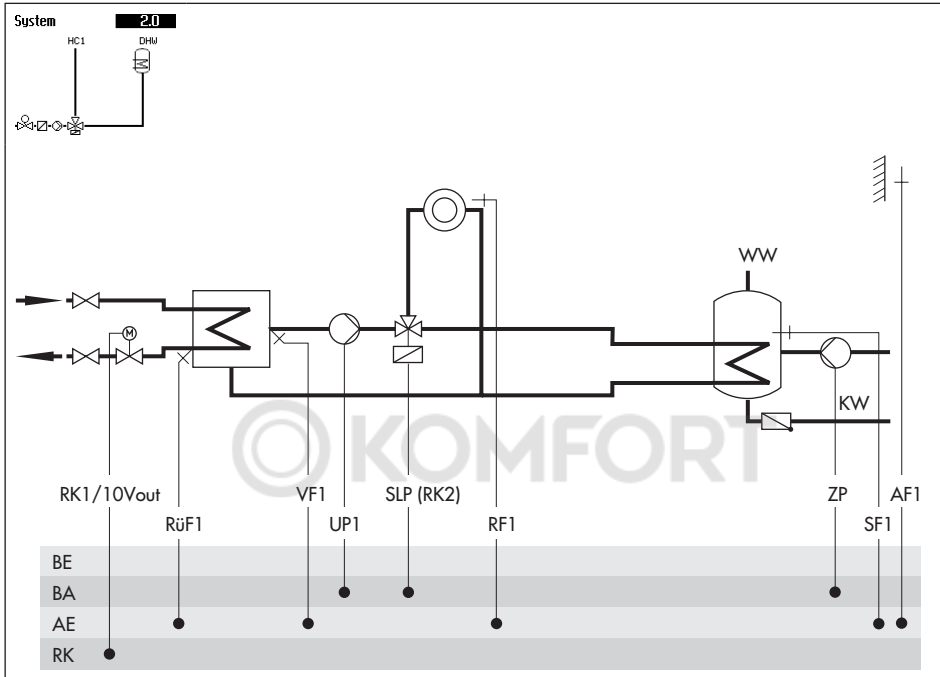

Default settings	
CO1 > F01	- 0 (without RF1)
CO1 > F02	- 1 (with AF1)
CO1 > F03	- 1 (with Rüf1)
CO4 > F01	- 1 (with SF1)
CO4 > F02	- 0 (without SF2)
CO5 > F07	- 0 (without error message at terminal 29)

System Anl 2.1

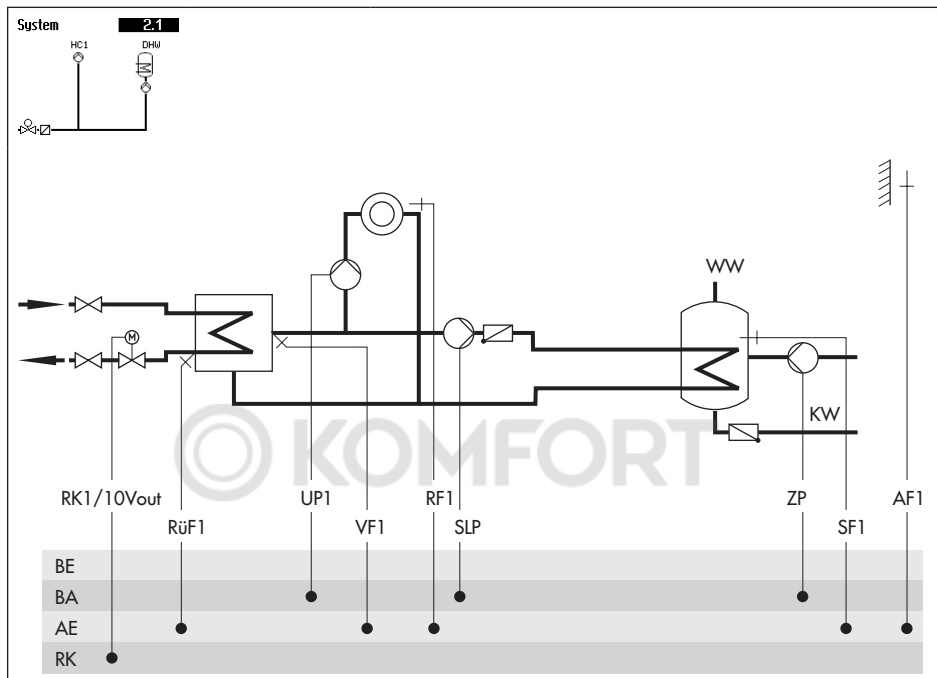

Default settings	
CO1 > F01	- 0 (without RF1)
CO1 > F02	- 1 (with AF1)
CO1 > F03	- 1 (with RüF1)
CO4 > F01	- 1 (with SF1)
CO4 > F02	- 0 (without SF2)
CO5 > F07	- 0 (without error message at terminal 29)

System Anl 2.2

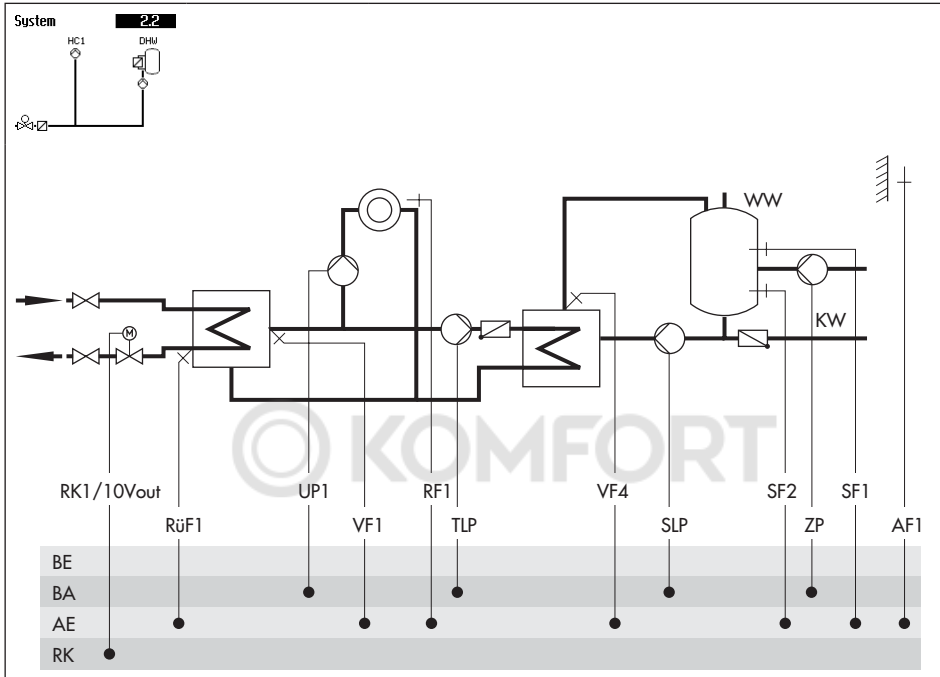

Default settings	
CO1 > F01	- 0 (without RF1)
CO1 > F02	- 1 (with AF1)
CO1 > F03	- 1 (with RüF1)
CO4 > F01	- 1 (with SF1)
CO4 > F02	- 1 (with SF2)
CO4 > F05	- 0 (without VF4)
CO5 > F07	- 0 (without error message at terminal 29)

System Anl 2.3

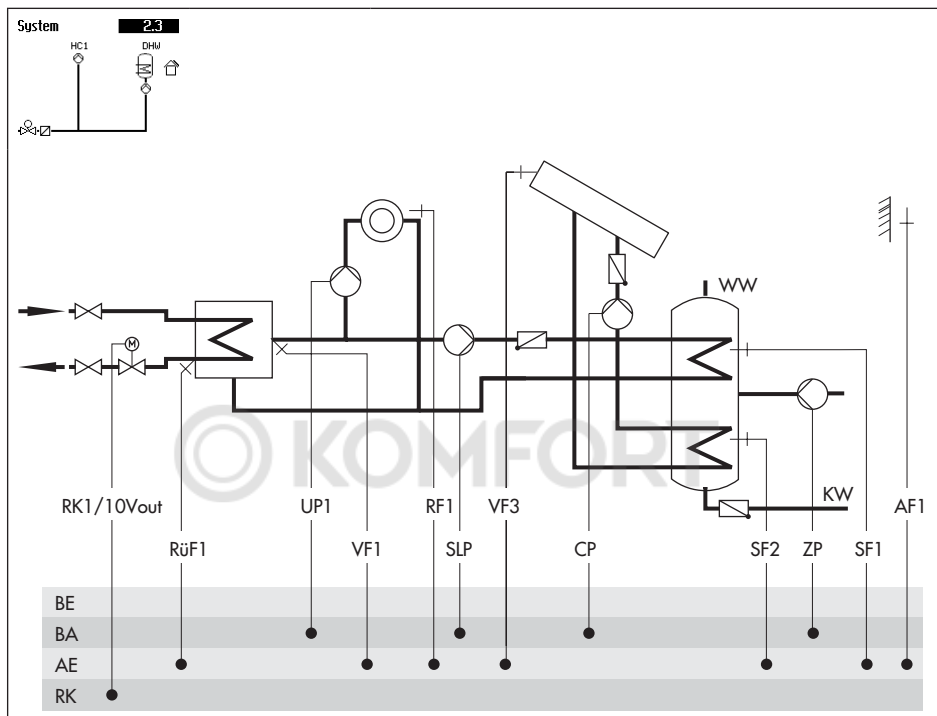

Default settings

CO1 > F01	- 0 (without RF1)
CO1 > F02	- 1 (with AF1)
CO1 > F03	- 1 (with RüF1)
CO4 > F01	- 1 (with SF1)
CO5 > F07	- 0 (without error message at terminal 29)

System Anl 3.0

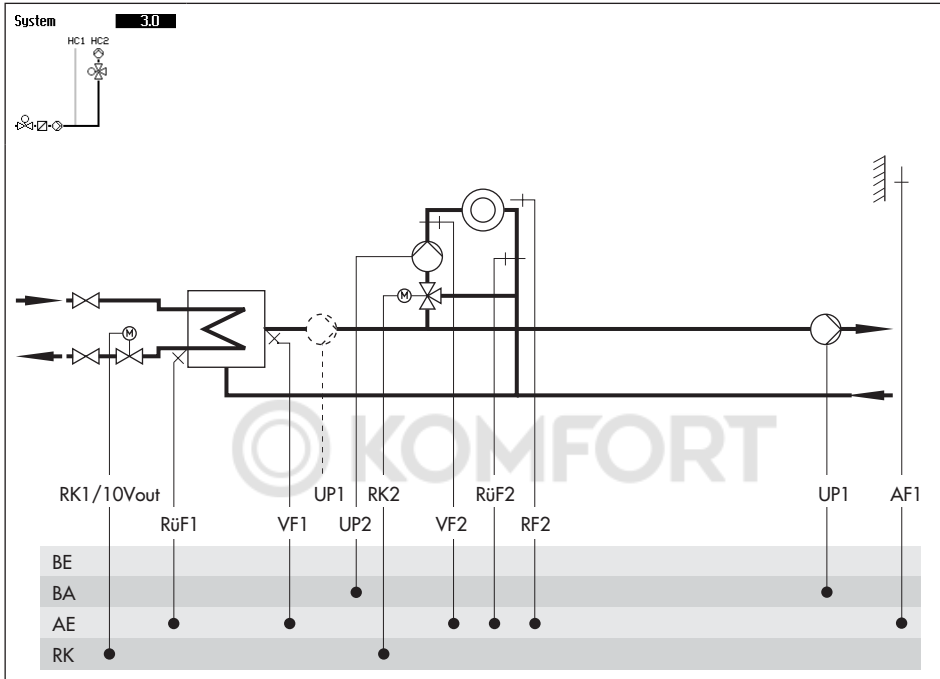

Default settings	
CO1 > F02	- 1 (with AF1)
CO1 > F03	- 1 (with RüF1)
CO2 > F01	- 0 (without RF2)
CO2 > F03	- 0 (without RüF2)
CO5 > F07	- 0 (without error message at terminal 23)

System Anl 3.5

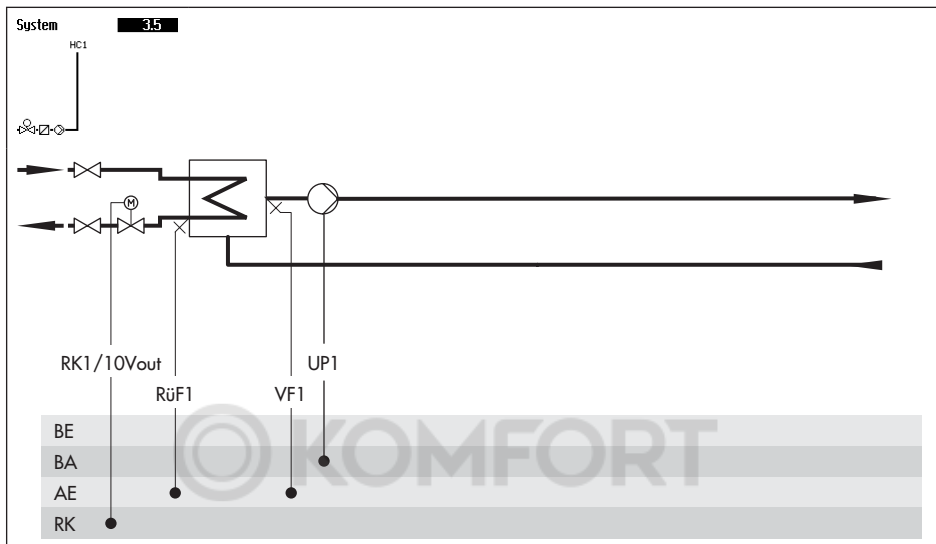

Note	Closed control circuit and UP1 are only active during the processing for an external demand
Default settings	
CO1 > F03	- 1 (with RüF1)
CO5 > F07	- 0 (without error message at terminal 29)

System Anl 4.0

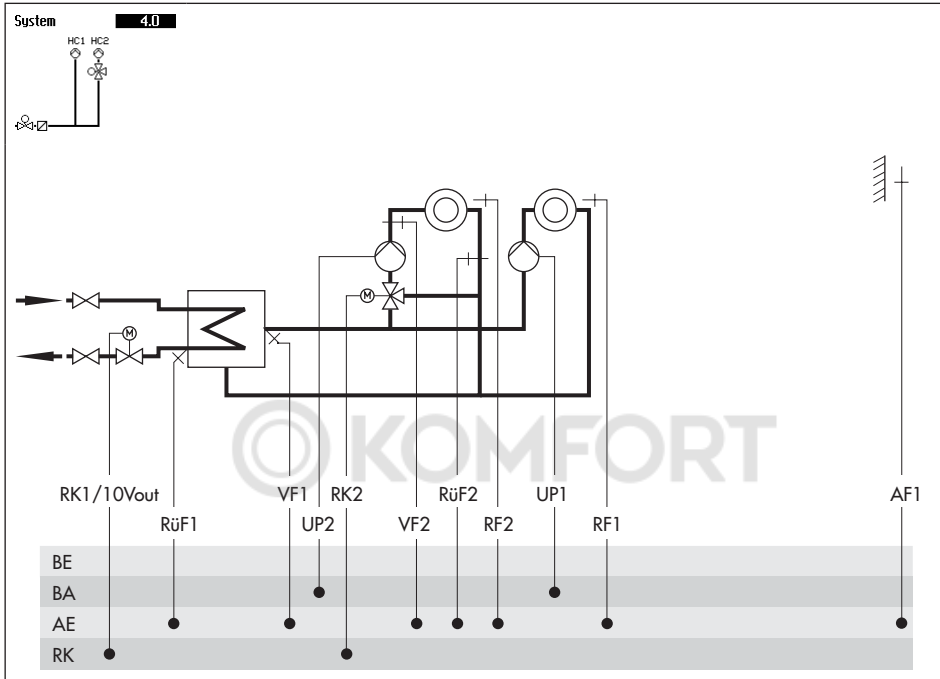

Default settings	
CO1 > F01	- 0 (without RF1)
CO1 > F02	- 1 (with AF1)
CO1 > F03	- 1 (with RüF1)
CO2 > F01	- 0 (without RF2)
CO2 > F03	- 0 (without RüF2)
CO5 > F07	- 0 (without error message at terminal 23)

System Anl 4.1

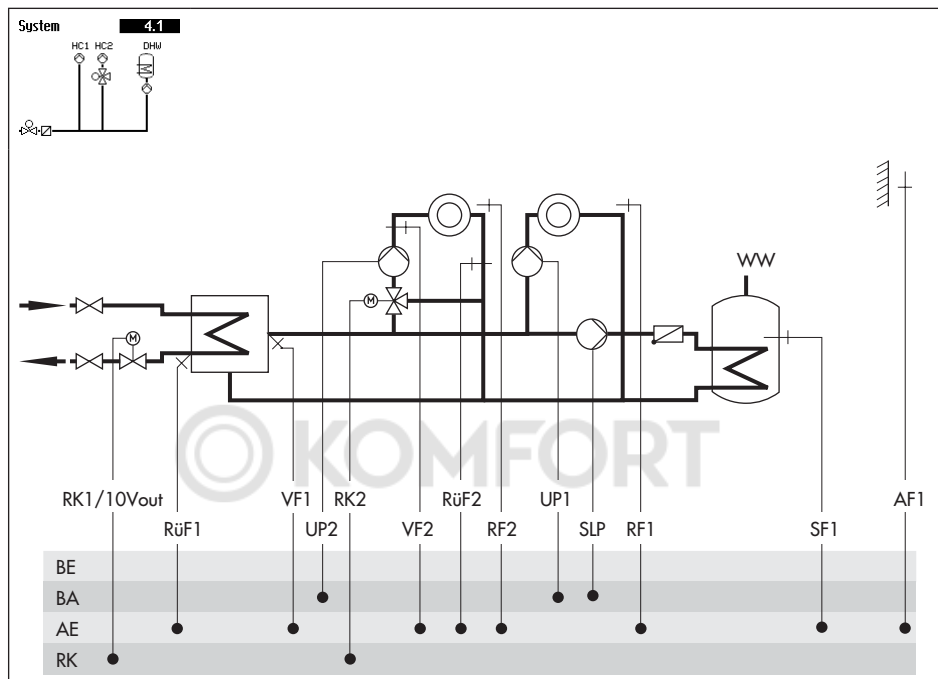

Default settings

CO1 > F01	- 0 (without RF1)
CO1 > F02	- 1 (with AF1)
CO1 > F03	- 1 (with RüF1)
CO2 > F01	- 0 (without RF2)
CO2 > F03	- 0 (without RüF2)
CO4 > F01	- 1 (with SF1)
CO4 > F02	- 0 (without SF2)

System Anl 4.5

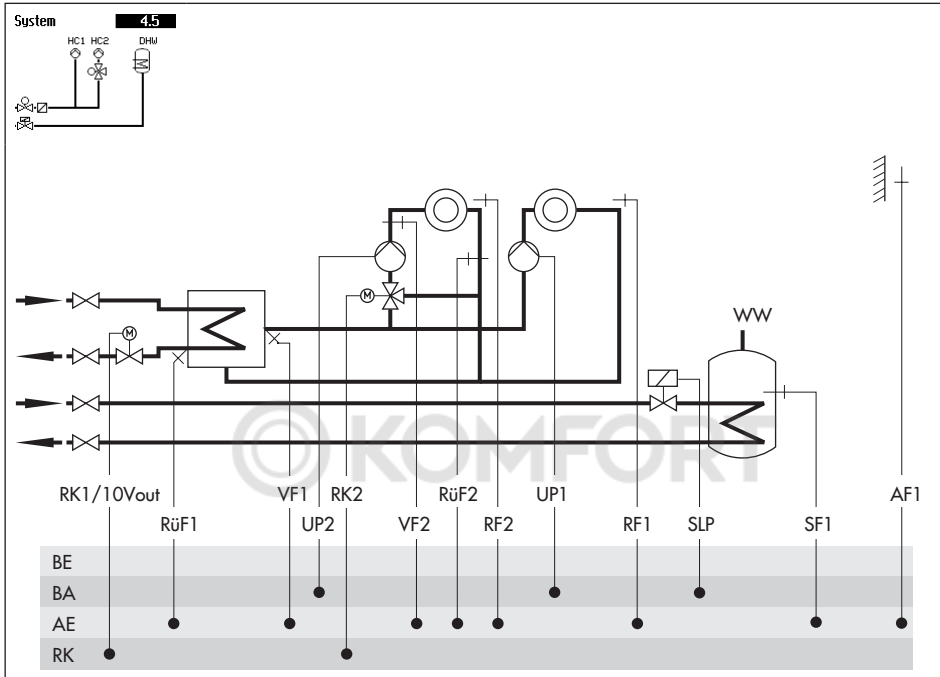

Default settings	
CO1 > F01	- 0 (without RF1)
CO1 > F02	- 1 (with AF1)
CO1 > F03	- 1 (with RüF1)
CO2 > F01	- 0 (without RF2)
CO2 > F03	- 0 (without RüF2)
CO4 > F01	- 1 (with SF1)
CO4 > F02	- 0 (without SF2)

System Anl 10.0-1

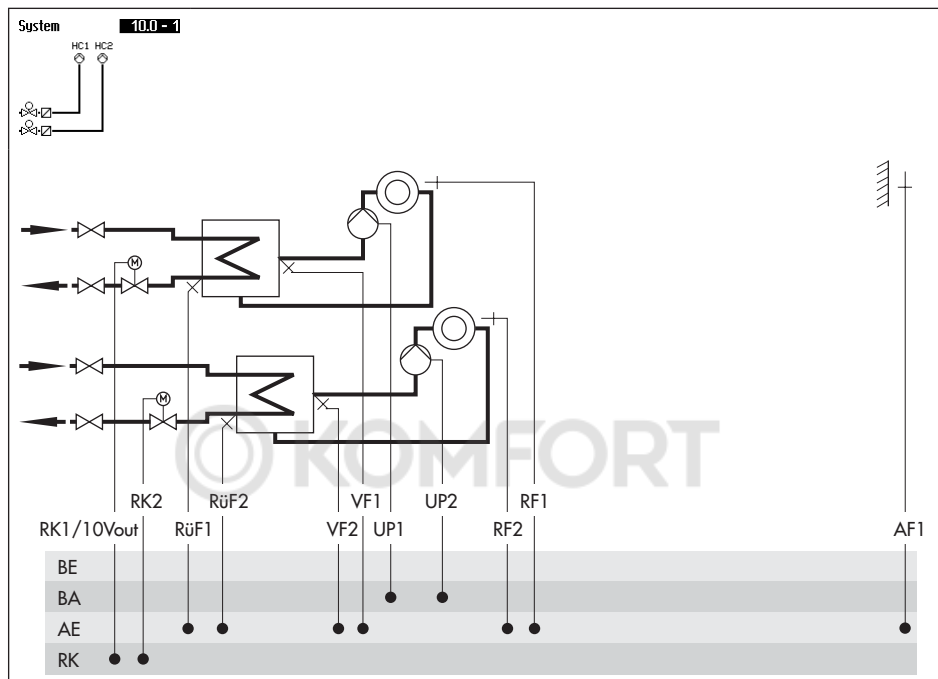

Default settings

CO1 > F01	- 0 (without RF1)
CO1 > F02	- 1 (with AF1)
CO1 > F03	- 1 (with RüF1)
CO2 > F01	- 0 (without RF2)
CO2 > F03	- 1 (with RüF2)
CO5 > F07	- 0 (without error message at terminal 23)

System Anl 10.0-2

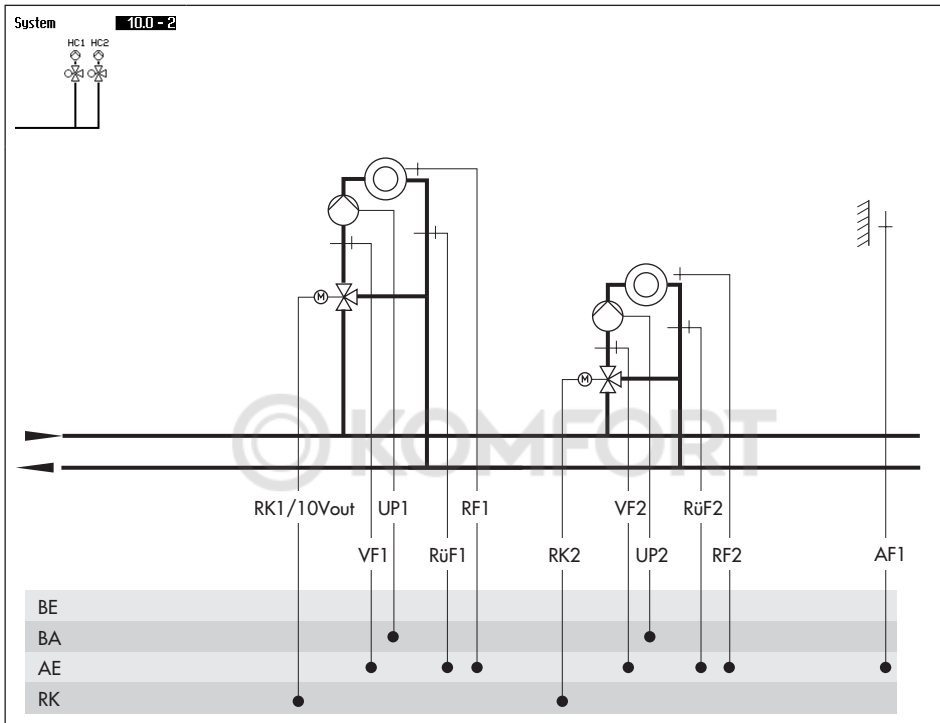

Default settings	
CO1 > F01	- 0 (without RF1)
CO1 > F02	- 1 (with AF1)
CO1 > F03	- 1 (with RüF1)
CO2 > F01	- 0 (without RF2)
CO2 > F03	- 1 (with RüF2)
CO5 > F07	- 0 (without error message at terminal 23)

System Anl 11.0

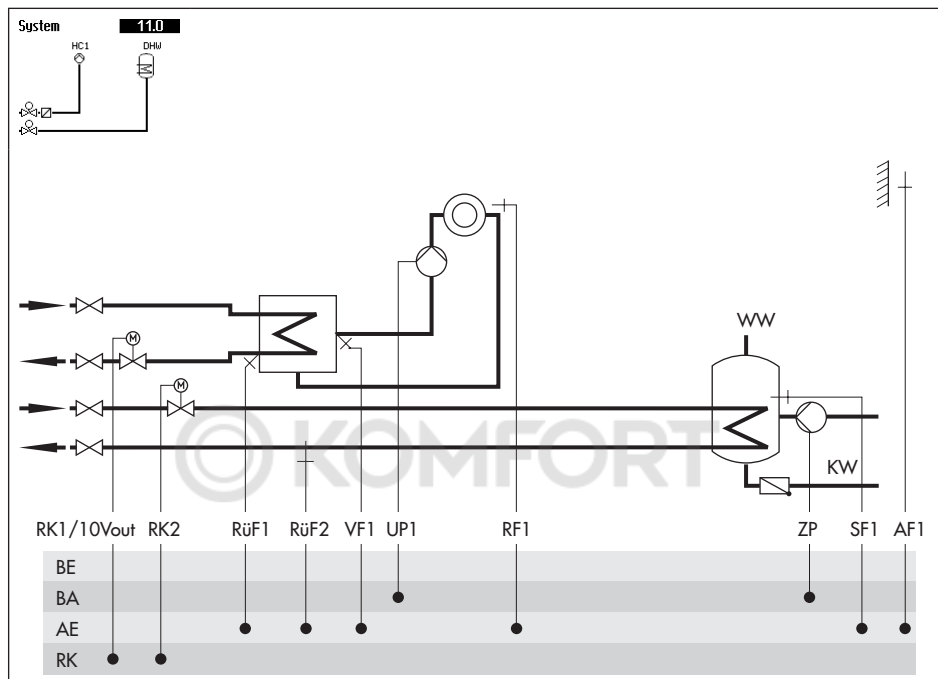

Default settings

CO1 > F01	- 0 (without RF1)
CO1 > F02	- 1 (with AF1)
CO1 > F03	- 1 (with RüF1)
CO4 > F03	- 0 (without RüF2)
CO5 > F07	- 0 (without error message at terminal 23)

System Anl 11.1-1

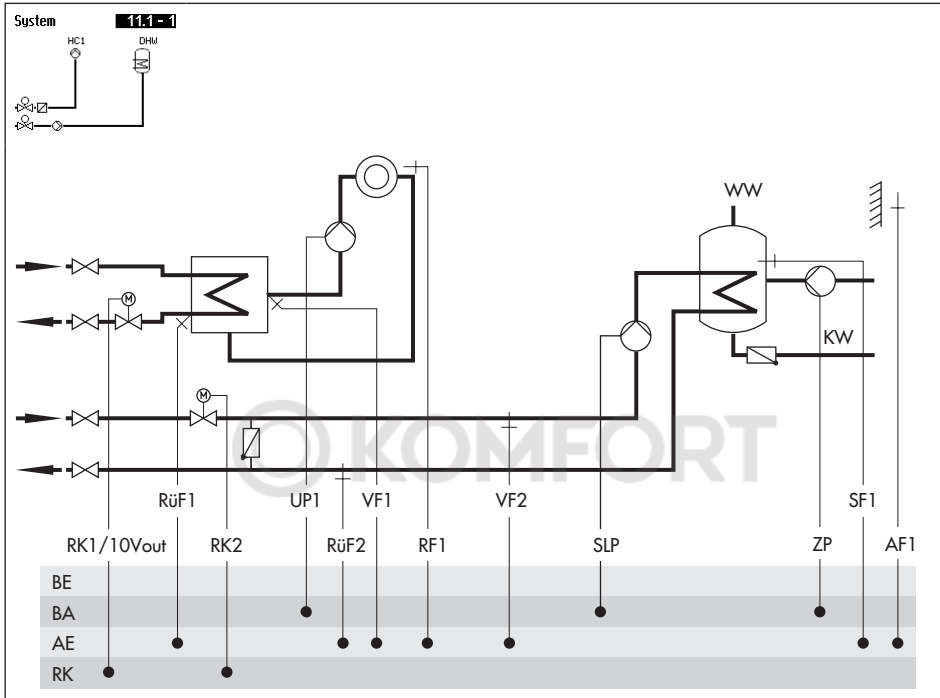

Default settings	
CO1 > F01	- 0 (without RF1)
CO1 > F02	- 1 (with AF1)
CO1 > F03	- 1 (with RüF1)
CO4 > F01	- 1 (with SF1)
CO4 > F02	- 0 (without SF2)
CO4 > F03	- 0 (without RüF2)

System Anl 11.1-2

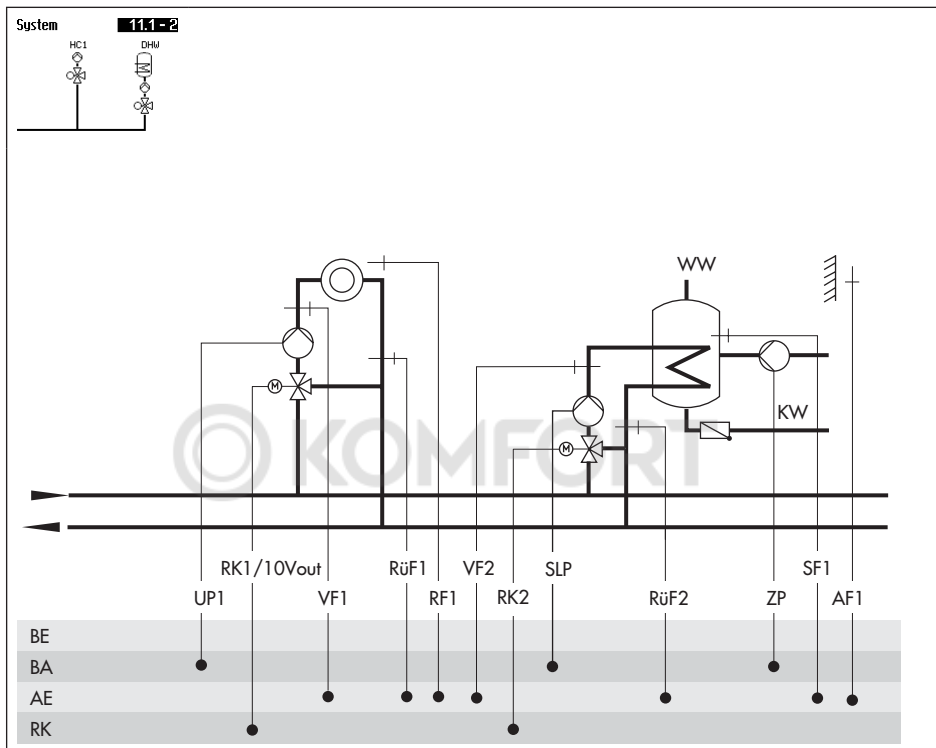

Default settings

CO1 > F01	- 0 (without RF1)
CO1 > F02	- 1 (with AF1)
CO1 > F03	- 1 (with RüF1)
CO4 > F01	- 1 (with SF1)
CO4 > F02	- 0 (without SF2)
CO4 > F03	- 0 (without RüF2)

System Anl 11.1-3

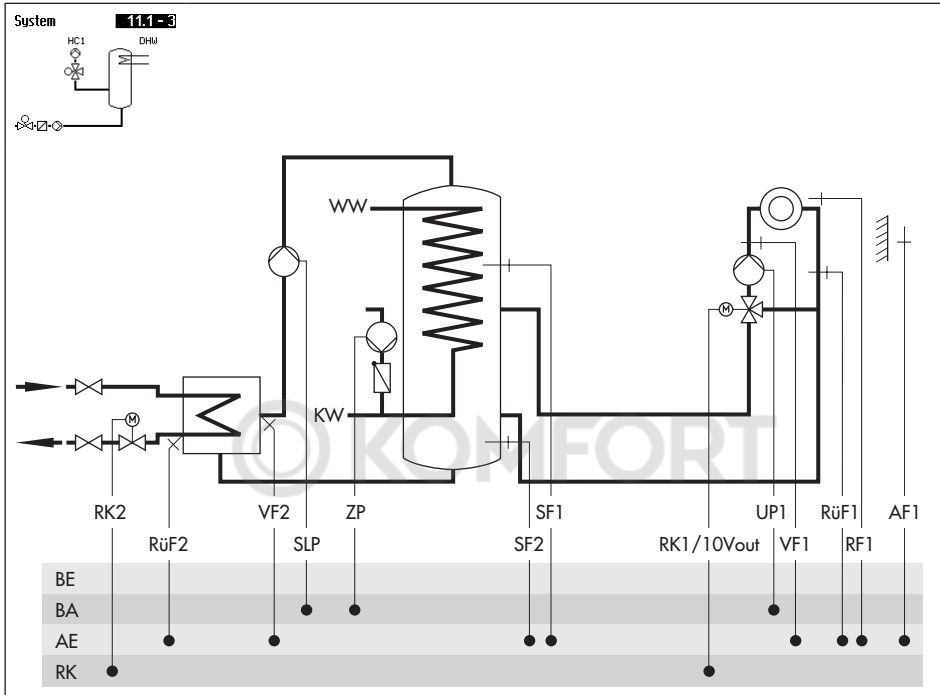

Default settings	System Anl 11.1	System Anl 11.2
CO1 > F01	- 0 (without RF1)	- 0 (without RF1)
CO1 > F02	- 1 (with AF1)	- 1 (with AF1)
CO1 > F03	- 1 (with RüF1)	- 1 (with RüF1)
CO4 > F01	- 1 (with SF1)	- 1 (with SF1)
CO4 > F02	- 0 (without SF2)	- 1 (with SF2)
CO4 > F03	- 0 (without RüF2)	- 0 (without RüF2)

System Anl 11.2

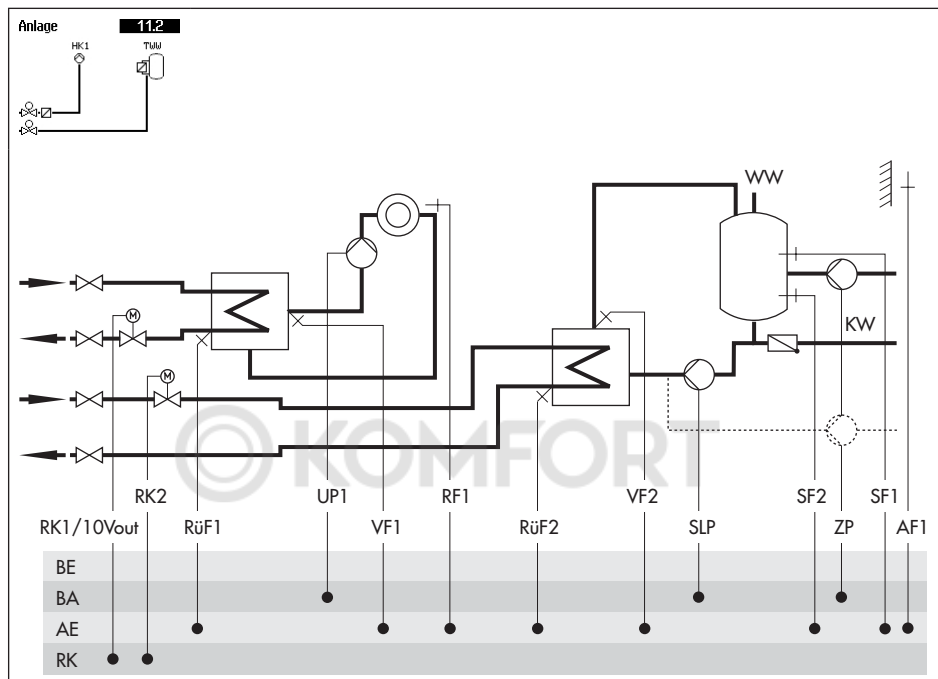

Default settings

CO1 > F01	- 0 (without RF1)
CO1 > F02	- 1 (with AF1)
CO1 > F03	- 1 (with RüF1)
CO4 > F01	- 1 (with SF1)
CO4 > F02	- 1 (with SF2)
CO4 > F03	- 0 (without RüF2)

System Anl 11.5

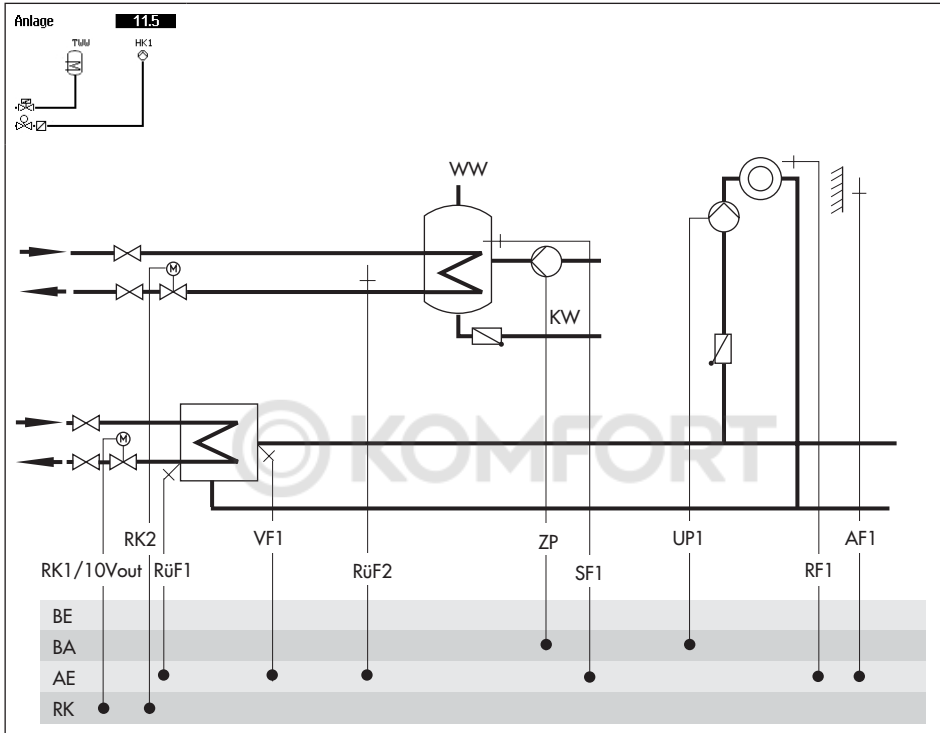

Note	DHW circuit with adjustable valve position for storage tank charging in absolute priority operation. By using RüF2, the ready-adjusted valve position is subject to the return flow temperature limitation.
Default setting	
CO1 > F01	- 0 (without RF1)
CO1 > F02	- 1 (with AF1)
CO4 > F02	- 0 (without SF2)
CO4 > F03	- 1 (with RüF2)

System Anl 11.6

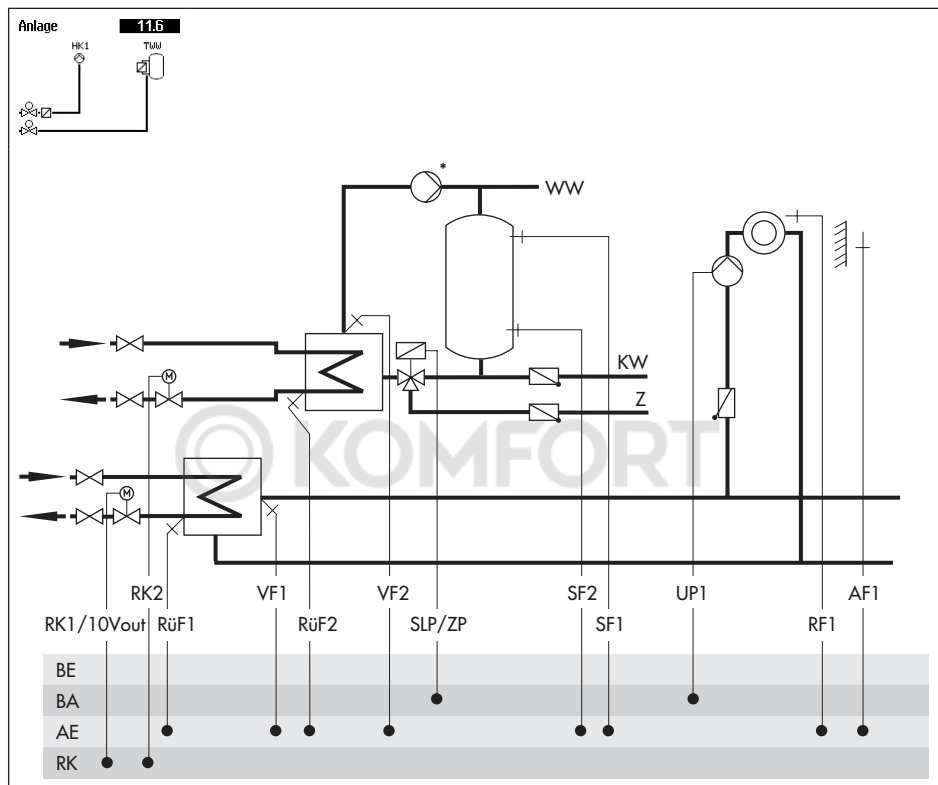

* Note:

Install a continuously running pump in the DHW circuit and connect it directly to the main power supply.

Default settings

CO1 > F01	- 0 (without RF1)
CO1 > F02	- 1 (with AF1)
CO1 > F03	- 1 (with RüF1)
CO4 > F01	- 1 (with SF1)
CO4 > F02	- 1 (with SF2)
CO4 > F03	- 0 (without RüF2)

System Anl 11.9

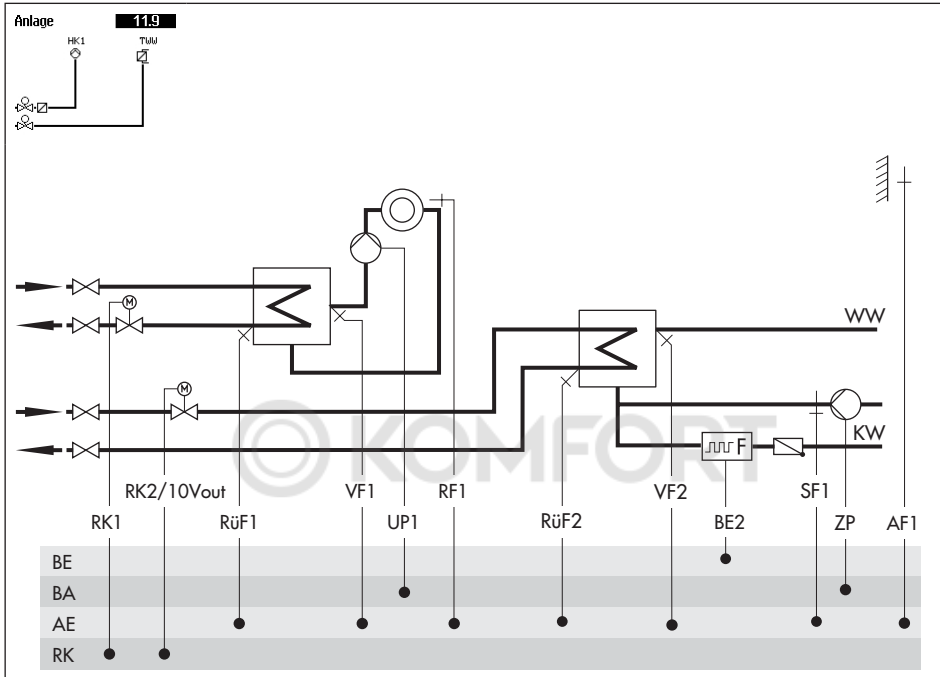

Default settings	
CO1 > F01	- 0 (without RF1)
CO1 > F02	- 1 (with AF1)
CO1 > F03	- 1 (with RüF1)
CO4 > F01	- 0 (without SF1)
CO4 > F03	- 0 (without RüF2)
CO4 > F04	- 0 (without flow rate sensor)
CO5 > F07	- 0 (without error message at terminal 23)

System Anl 16.0

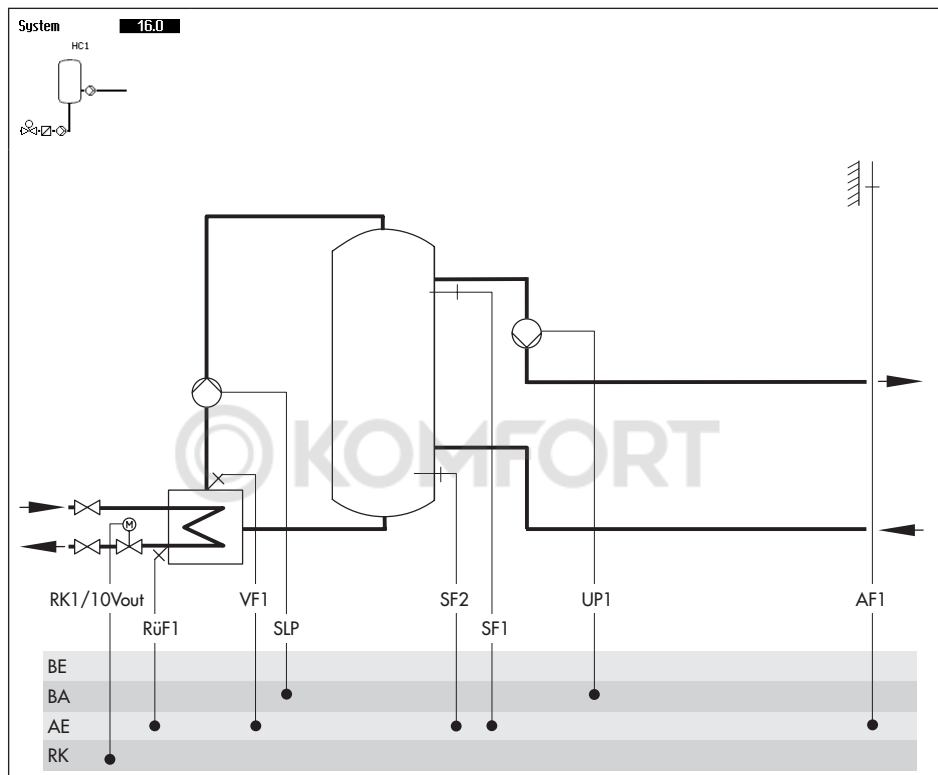

Default settings

CO1 > F02	- 1 (with AF1)
CO1 > F03	- 1 (with RüF1)
CO5 > F07	- 0 (without error message at terminal 29)

System Anl 16.1

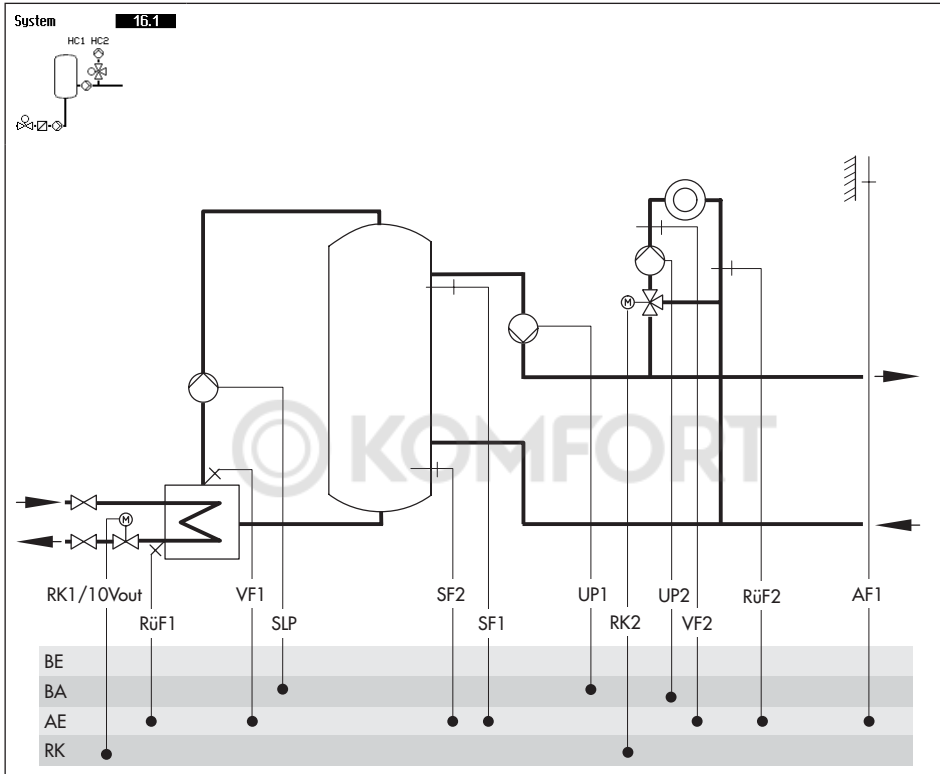

Default settings	
CO1 > F02	- 1 (with AF1)
CO1 > F03	- 1 (with RüF1)
CO2 > F03	- 0 (without RüF2)

System Anl 16.2

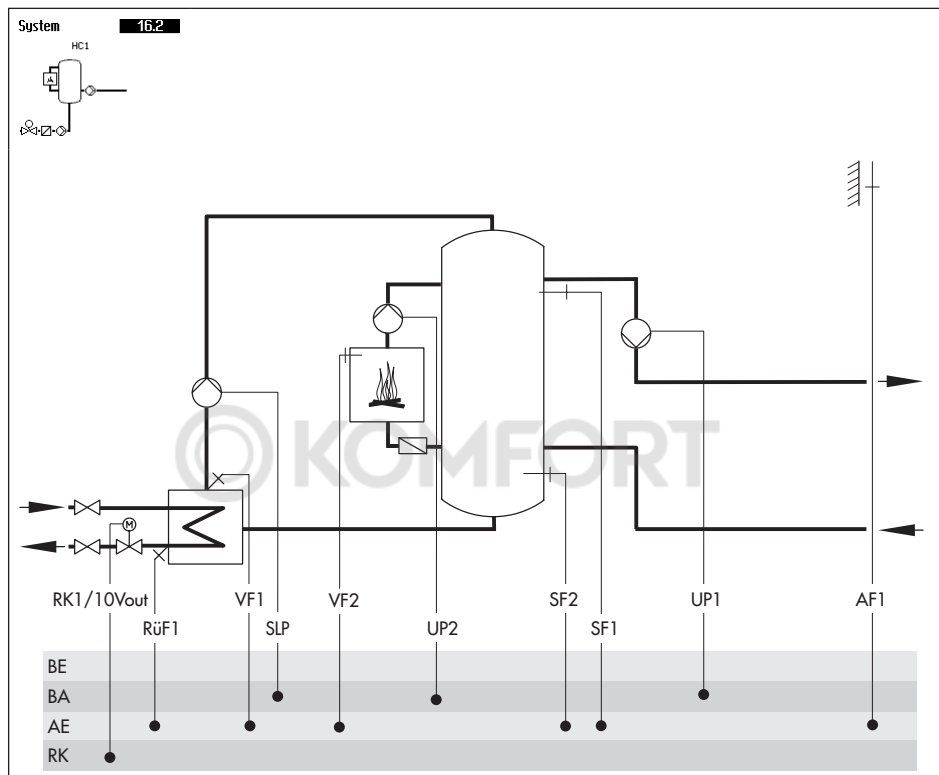

Default settings

CO1 > F02	- 1 (with AF1)
CO1 > F03	- 1 (with RüF1)
CO5 > F07	- 0 (without error message at terminal 29)

System Anl 16.3

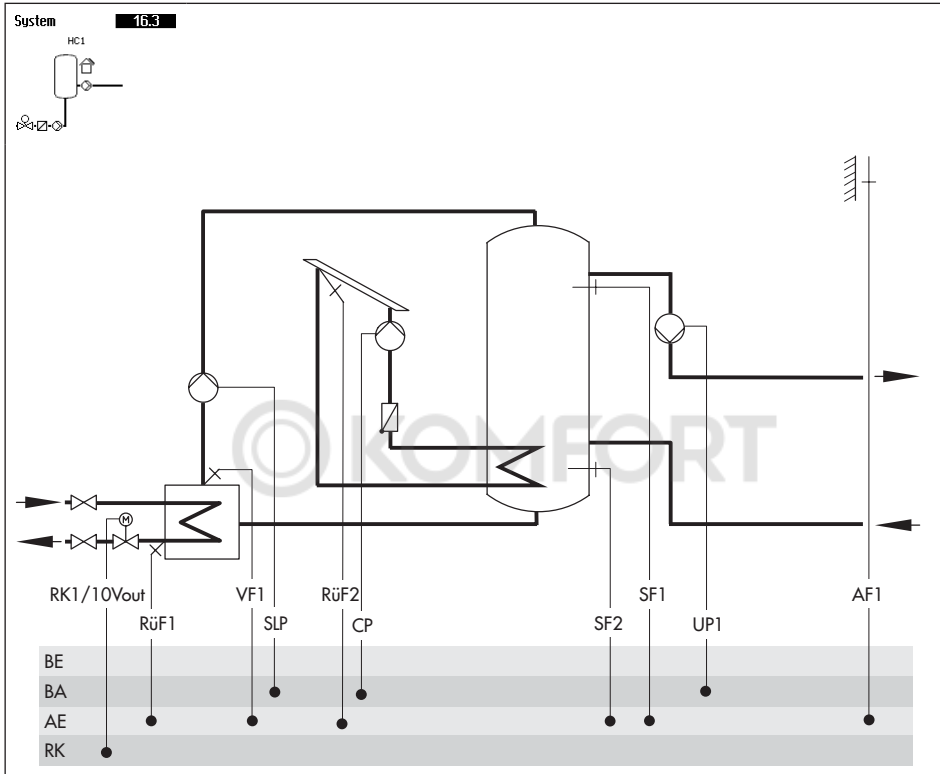

Default settings

CO1 > F02	- 1 (with AF1)
CO1 > F03	- 1 (with RüF1)
CO5 > F07	- 0 (without error message at terminal 29)

System Anl 16.4

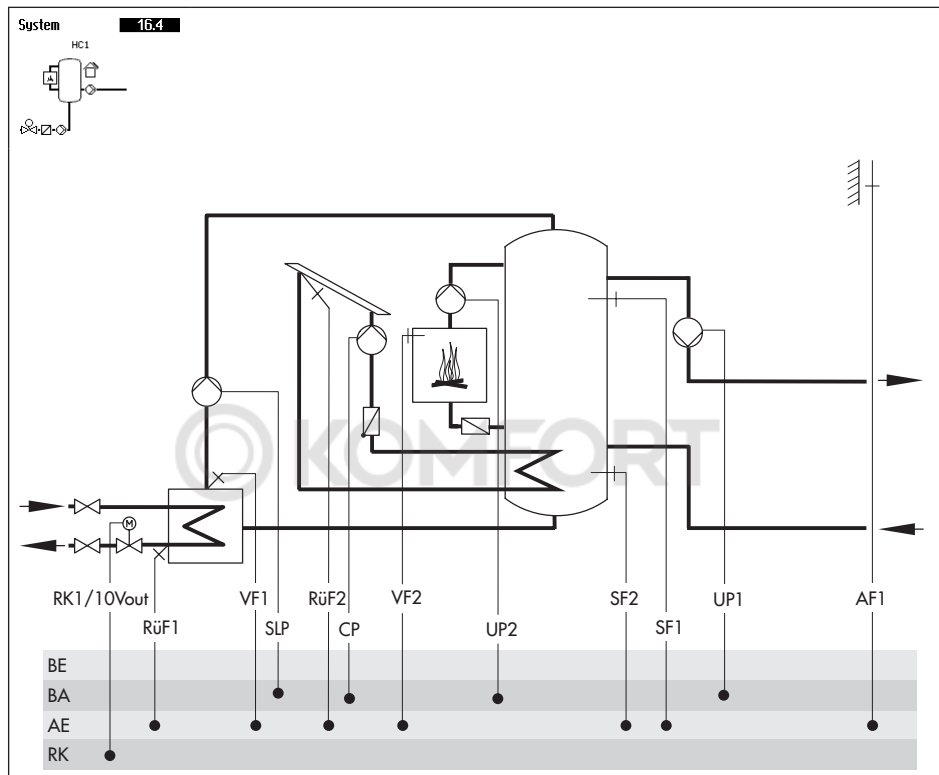

Default settings

CO1 > F02	- 1 (with AF1)
CO1 > F03	- 1 (with RüF1)
CO5 > F07	- 0 (without error message at terminal 29)

System Anl 16.6

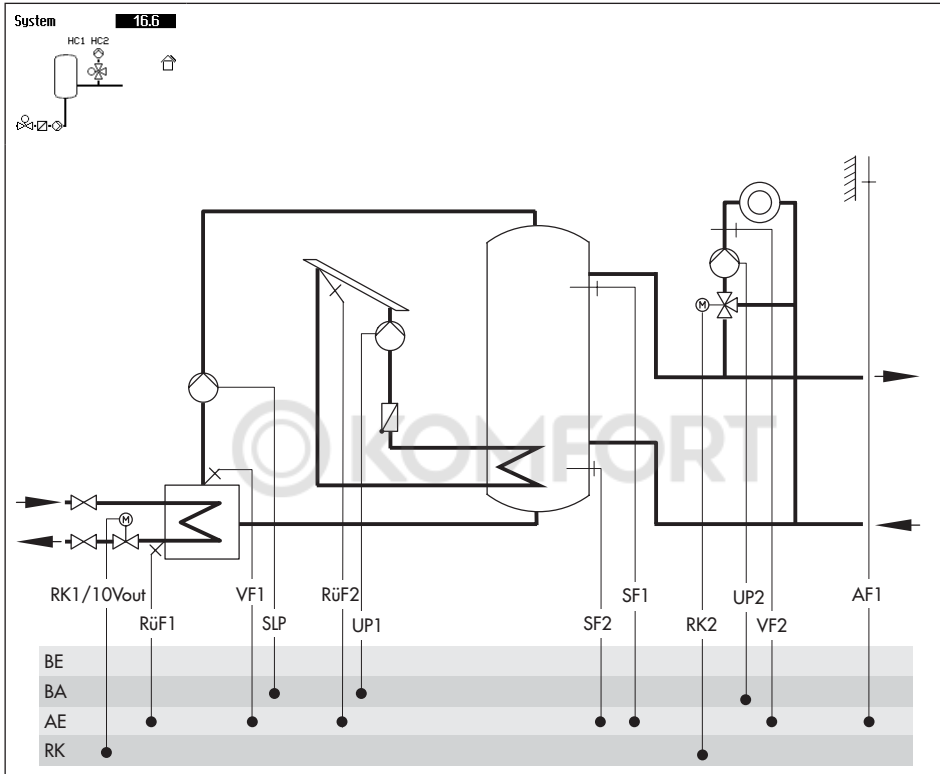

Default settings	
CO1 > F02	- 1 (with AF1)
CO1 > F03	- 1 (with RüF1)
CO2 > F02	- 0 (without AF2 for RK2)
CO2 > F03	- 0 (without RüF2)

6 Functions of the heating circuit

Which controller functions are available depends on the selected system code number (AnI).

6.1 Outdoor-temperature-controlled control

When outdoor-temperature-compensated control is used, the flow temperature is controlled based on the outdoor temperature. The heating characteristic in the controller defines the flow temperature set point as a function of the outdoor temperature (see Fig. 3). The outdoor temperature required for outdoor-temperature-compensated control can either be measured at an outdoor sensor or received over the 0 to 10 V input.

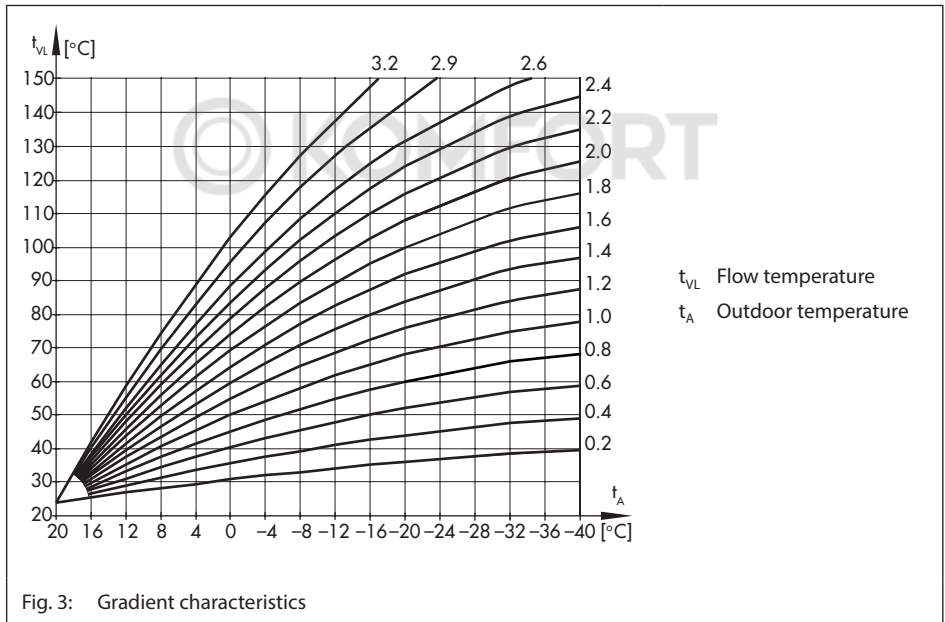

Functions	WE	Configuration
Outdoor sensor	0	CO1 > F02 - 1
0 to 10 V signal for outdoor temperature	0	CO5 > F23 - 1
	Input	Direction: Input
	-20.0 °C 50.0 °C	Lower transmission range: -50.0 to 100.0 °C Upper transmission range: -50.0 to 100.0 °C

6.1.1 Gradient characteristic

Basically, the following rule applies: a decrease in the outdoor temperature causes the flow temperature to increase in order to keep the room temperature constant. By varying the gradient and level parameters, you can adapt the characteristic to your individual requirements:

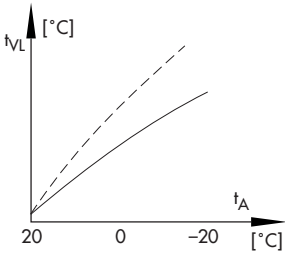

The gradient needs to be increased if the room temperature drops when it is cold outside.

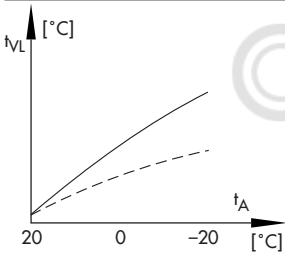

The gradient needs to be decreased if the room temperature drops when it is cold outside.

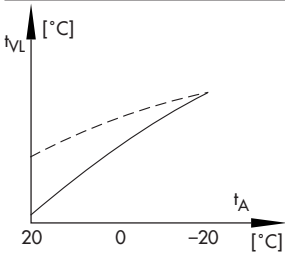

The level needs to be increased and the gradient decreased if the room temperature drops when it is mild outside.

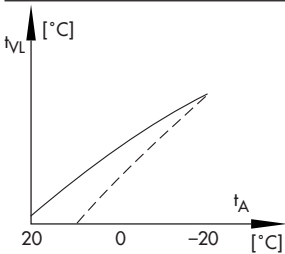

The level needs to be decreased and the gradient increased if the room temperature rises when it is mild outside.

Outside the times-of-use, reduced set points are used for control: the reduced flow set point is calculated as the difference between the adjusted values for 'Day set point' (rated room temperature) and 'Night set point' (reduced room temperature). The 'Max. flow temperature' and 'Min. flow temperature' parameters mark the upper and lower limits of the flow temperature. A separate gradient characteristic can be selected for the limitation of the return flow temperature.

Examples for adjusting the characteristic:

- Old building, radiator design 90/70: Gradient approx. 1.8
- New building, radiator design 70/55: Gradient approx. 1.4
- New building, radiator design 55/45: Gradient approx. 1.0
- Underfloor heating depending on arrangement: Gradient smaller than 0.5

i Note

Particularly for control operation without room sensor, the room temperatures set for day ('Day set point') and night ('Night set point') only become effective satisfactorily when the heating characteristic has been adapted to the building/heating surface layout.

Functions	WE	Configuration
Four-point characteristic	0	CO1, 2 > F11 - 0
Parameters	WE	Switch position: value range
Day set point	20.0 °C	☀️: 0.0 to 40.0 °C
Night set point	15,0 °C	🌙: 0.0 to 40.0 °C
Parameters	WE	Parameters: value range
Flow gradient	1.8*	PA1, 2 > P01: 0.2 to 3.2
Level (parallel shift)	0.0 °C	PA1, 2 > P02: -30.0 to 30.0 °C
Min. flow temperature	20.0 °C	PA1, 2 > P06: -5.0 to 150.0 °C
Max. flow temperature	90.0 °C*	PA1, 2 > P07: 5.0 to 150.0 °C
* With CO1, 2 > F05 - 1 the following applies:	Gradient: 0.2 to 1.0 (1.0)	Max. flow temperature: 5.0 to 50.0 °C (50.0 °C)

6.1.2 Four-point characteristic

The four-point characteristic allows you to define your own heating characteristic. It is defined by four points for the outdoor temperature, flow temperature, reduced flow temperature and return flow temperature. The 'Max. flow temperature' and 'Min. flow temperature' parameters mark the upper and lower limits of the flow temperature.

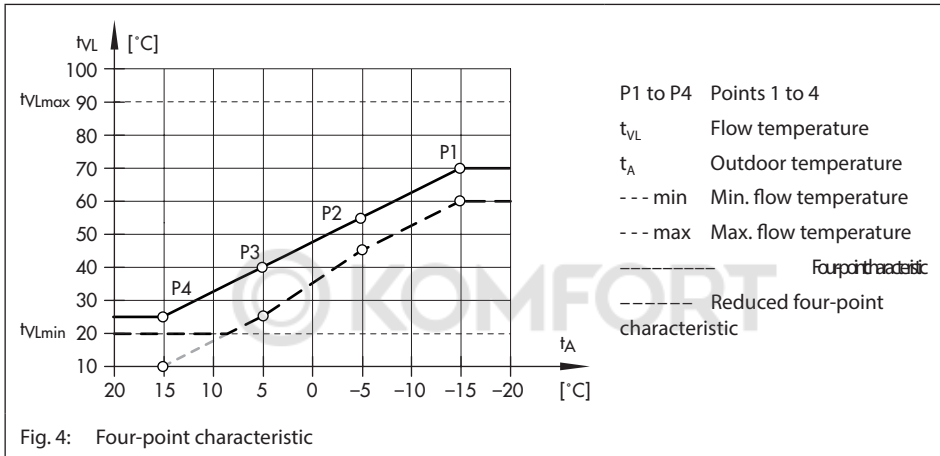

i Note

- The 'Day set point' and 'Night set point' parameters are no longer available when the four-point characteristic has been selected, provided no additional functions (e.g. optimization, flash adaptation) have been selected.
- The four-point characteristic function can only be activated when the adaptation function is not active (CO1, 2 > F08 - 0).

Functions		WE	Configuration
Adaptation		0	CO1, 2 > F08 - 0
Four-point characteristic		0	CO1, 2 > F11 - 1
Parameters		WE	Parameters: value range
Outdoor temperature	Point 1	-15,0 °C	PA1, 2 > P05: -50,0 bis 50,0 °C
	Point 2	-5,0 °C	
	Point 3	5,0 °C	
	Point 4	15,0 °C	

Parameters		WE	Parameters: value range
Flow temperature	Point 1	70.0 °C	PA1, 2 > P05: -5.0 to 150.0 °C
	Point 2	55.0 °C	
	Point 3	40.0 °C	
	Point 4	25.0 °C	
Reduced flow temperature	Point 1	60.0 °C	PA1, 2 > P05: -5.0 to 150.0 °C
	Point 2	40.0 °C	
	Point 3	20.0 °C	
	Point 4	20.0 °C	
Return flow temperature	Points 1 to 4	65.0 °C	PA1, 2 > P05: 5.0 to 90.0 °C
Min. flow temperature		20.0 °C	PA1, 2 > P06: -5.0 to 150.0 °C
Max. flow temperature		90.0 °C*	PA1, 2 > P07: 5.0 to 150.0 °C
* With CO1, 2 > F05 - 1 the following applies: Max. flow temperature: 5.0 to 50.0 °C (50.0 °C)			

6.2 Fixed set point control

During the times-of-use, the flow temperature can be controlled according to a fixed set point. Outside the times-of-use, the controller regulates to a reduced flow temperature. Set the desired rated flow temperature as 'Day set point' and the reduced flow temperature as 'Night set point'.

Functions	WE	Configuration
Outdoor sensor		CO1 > F02 - 0
Parameters	WE	Switch position: value range
Day set point	50.0 °C	↓☀: Min. to max. flow temperature
Night set point	30.0 °C	↓☾: Min. to max. flow temperature
Parameters	WE	Parameters: value range
Min. flow temperature	20.0 °C	PA1, 2 > P06: -5.0 to 150.0 °C
Max. flow temperature	90.0 °C	PA1, 2 > P07: 5.0 to 150.0 °C

Note

A fixed set point control in heating circuit HC2 can only be configured with CO2 > F02 - 0 when CO1 > F02 - 0 is also configured since heating circuit HC2 configured with CO2 > F02 - 0 only uses the measured outdoor temperature provided by heating circuit HC1.

6.3 Underfloor heating/drying of jointless floors

Using function block setting CO1, 2 > F05 - 1, the respective heating circuit is configured as an underfloor heating circuit. In doing so, the controller at first only limits the value ranges of the heating characteristic gradient and the maximum flow temperature in PA1, 2 parameter levels:

- Value range of the gradient: 0.2 to 1.0
- Value range of the maximum flow temperature: 5 to 50 °C

In addition, it is possible to activate the drying of jointless floors function. In connection with this, the function block parameters are listed which appear after activating this function block. They determine the drying process: the first heating up phase starts at the entered Start temperature, which has a flow temperature of 25 °C in its default setting. The start temperature is constantly regulated for the days entered in 'Hold (days)'. Afterwards, this temperature is raised by the value entered in 'Temp. rise/day' within 24 hours, i.e. the default setting causes the flow temperature set point to rise to 30 °C 24 hours after the holding phase. If the maximum temperature is reached, it is kept constant for the number of days entered in 'Hold (days)'. The 'Temp. reduction/day' parameter determines the temperature reduction downwards. If the 'Temp. reduction/day' is set to 0, the temperature maintaining phase moves directly to automatic mode. If the function block parameter 'Start temperature' is set to 25 °C and 'Temp. rise/day' to 0.0 °C, the drying function runs as specified in Part 4 of DIN EN 1264: the drying of jointless floors function starts with a flow temperature of 25 °C, which is kept constant for three days. Afterwards, the controller switches to the maximum adjusted temperature. The further process remains unchanged. The drying of jointless floors function is activated using the adjusted 'Start temperature' by changing the setting 'Stop' to 'Start'. 'Start' is displayed when the drying function starts. The restarting stages 'Build-up', 'Hold' (holding the maximum temperature) and 'Reduction' can be selected to continue an interrupted drying process. The course of the drying process can be monitored in the operating level by reading the measured data of the associated heating circuit.

CO1	<input type="checkbox"/>	<input type="checkbox"/>	<input type="checkbox"/>	<input type="checkbox"/>	<input checked="" type="checkbox"/>	<input type="checkbox"/>	<input type="checkbox"/>	<input type="checkbox"/>	<input type="checkbox"/>	<input type="checkbox"/>	<input type="checkbox"/>	<input type="checkbox"/>	<input type="checkbox"/>	<input type="checkbox"/>	<input type="checkbox"/>	<input type="checkbox"/>	<input type="checkbox"/>	<input type="checkbox"/>	<input type="checkbox"/>
F05 Fußbodenheizung																			
F05	1																		
Startbedingung	Aufbau																		
F07 Optimierung	0																		
Startbedingung																			

The drying process has been successfully completed when 'Done' is displayed. This disappears from the display after resetting the display to Stop in CO1, 2 > F05 or after interrupting the power supply. Any power failure that occurs while the function is running automatically restarts the drying function. In systems in which the drying function had to be interrupted due to DHW heating (e.g. system Anl 2.1), storage tank charging does not occur while the drying function is active, provided it is not used for frost protection of the storage tank.

i Note

The function block parameter can only be accessed after starting the function by resetting to 'Stop' in CO1, 2 > F05.

Functions	WE	Configuration
Underfloor heating/drying of jointless floors	0	CO1, 2 > F05 - 1
	25.0 °C	Start temperature: 20.0 to 60.0 °C
	0	Hold (days): 0 to 10 days
	5.0 °C	Temp. rise/day: 1.0 to 10.0 °C
	45.0 °C	Maximum temperature: 25.0 to 60.0 °C
	4	Hold (days): 0 to 10 days
	0.0 °C	Temp. reduction/day: 0.0 to 10.0 °C
	Stop	Start condition: Stop, Start, Hold, Reduction

6.4 Outdoor temperature for rated operation (day)

If a heating circuit is in night mode (automatic mode, ☺), this circuit is switched to day mode whenever the outdoor temperature falls below 'Outdoor temperature for continuous day mode'. Reduced operation restarts after the outdoor temperature rises above the limit (plus 0.5 °C hysteresis).

This function is activated at very low temperatures to avoid that the building cools down excessively outside the times-of-use when low outdoor temperatures occur.

Parameters	WE	Parameters: value range
Outdoor temperature for continuous day mode	-15.0 °C	PA1, 2 > P09: -50.0 to 5.0 °C

6.5 Buffer tanks stems Anl 16.x

A heating characteristic based on a gradient or four entered points can be set in PA1 for the buffer tanks in systems Anl 16.x. A buffer tank set point for day operation and a buffer tank set point for night operation can be set without outdoor sensors in the customer level. An external demand transmitted from secondary controlled heating circuits, DHW circuit or an external request (over a 0 to 10 V or binary signal) can override the current buffer tank set point. The maximum demand is indicated as the buffer tank set point for SF1. If the temperature falls below the buffer tank set point at SF1, charging of the buffer tank is started.

The set point of the charging temperature is determined by the 'Minimum set point to charge buffer tank' parameter setting in the PA1 level. The automatic adaptation ('OT' setting) causes the set point of the charging temperature to always be above the current buffer tank set point by the value entered in 'Charging temperature boost'. Every other value entered in 'Minimum set point to charge buffer tank' is used as the minimum set point for the charging temperature which first starts to be variable at higher buffer tank set points. When a return flow temperature sensor RüF1 is used, the charging pump SLP ($CO1 > F22 - 1$) is first released to avoid cold charging when the temperature measured at RüF1 has reached the same temperature measured at SF1. The 'Stop charging of the buffer tank' parameter ($PA1 > P17$, default = AT) determines under which conditions the charging of the buffer tank is stopped. The automatic adaptation ('OT' setting) causes the buffer tank charging to be stopped when the temperature in the buffer tank reaches the value ('Buffer tank set point' + 'Hysteresis of buffer tank'). Every other value entered for 'Stop charging of the buffer tank' is rated as a fixed switch-off temperature for the buffer tank charging. When SF2 ($CO1 > F06 - 1$) is configured, SF2 is always used to stop the charging of the buffer tank.

The storage tank charging pump is not switched off until the lag time (entered 'Valve transit time T_y ' for RK1 multiplied by 'Lag time of charging pump') has elapsed. The operation of the feeder pump UP1 is either determined by the ZP time schedule or prompted over an external demand. For systems with downstream control circuits, either only this external demand or the demand of the downstream control circuits causes the feeder pump UP1 to be activated, depending on the $CO5 > F14$ setting. In systems Anl 16.3, 16.4 and 16.6, a solar circuit is integrated, which uses sensor SF2 for control. The collector circuit pump CP is activated when the temperature at the collector sensor RüF2 is higher than that at storage tank sensor SF2 by the value entered in 'Solar circuit pump ON'. It is deactivated when the temperature difference falls below the value entered in 'Solar circuit pump OFF', when the temperature at the storage tank sensor SF2 reaches 'Max. storage tank temperature' or when the collector temperature rises above 120 °C.

i Note

The buffer tank control circuit is deactivated as described in section 6.4. When predefined gradients of heating characteristic ($CO1 > F11 - 0$) are used, night mode is not possible in the buffer tank control circuit. In contrast to an active four-point characteristic ($CO1 > F11 - 1$): in this case, a four-point characteristic exists for day and night modes.

Functions	WE	Configuration
Storage tank sensor SF2	1	CO1 > F06 - 1
SLP depending on return flow temperature	0	CO1 > F22 - 1

Parameters	WE	Parameters: value range
Minimum set point to charge buffer tank	AT	PA1 > P16: OT to 90.0 °C
Stop charging of the buffer tank	AT	PA1 > P17: OT to 90.0 °C
Charging temperature boost	6.0 °C	PA1 > P18: 0.0 to 50.0 °C
Lag time of charging pump	1.0	PA1 > P19: 0.0 to 10.0
Solar circuit pump ON	10.0 °C	PA4 > P10: 1.0 to 30.0 °C
Solar circuit pump OFF	3.0 °C	PA4 > P11: 0.0 to 30.0 °C
Max. storage tank temperature	80.0 °C	PA4 > P12: 20.0 to 90.0 °C
Start temperature for boiler pump	60.0 °C	PA5 > P01: 20.0 to 90.0 °C
Boiler pump hysteresis	5.0 °C	PA5 > P02: 0.0 to 30.0 °C

6.6 Summer mode

Summer mode is activated depending on the mean daytime temperature (measured between 7.00 h and 22.00 h) during the adjusted summer time period. If the mean daytime temperature exceeds the 'Boost' on the number of successive days set in 'No. days until activation', summer mode is activated on the following day. This means that the valves in all heating circuits are closed and the circulation pumps are switched off after $t = 2 \times$ valve transit time. If the mean daytime temperature falls below the 'Limit' on the number of successive days set in 'No. days until deactivation', summer mode is deactivated on the following day.

Functions	WE	Configuration
Summer mode	0	CO5 > F04 - 1
	01.06 - 30.09	Time: Adjustable as required
	2	No. days until activation: 1 to 3
	1	No. days until deactivation: 1 to 3
	18.0 °C	Limit: 0.0 to 30.0 °C

i Note

Summer mode only becomes effective when the controller is in automatic mode (Ⓒ).

6.7 Delayed outdoor temperature adaptation

The calculated outdoor temperature is used to determine the flow temperature set point. The heat response is delayed when the outdoor temperature either increases or decreases or both. If the outdoor temperature varies by, for example 12 °C within a very short period of time, the calculated outdoor temperature is adapted to the actual outdoor temperature in small steps (delay time of 3 °C/h) over a time period of $t = \frac{12 \text{ °C}}{3 \text{ °C/h}} = 4 \text{ h}$.

i Note

The delayed outdoor temperature adaptation helps avoid unnecessary overloads of central heating stations in combination with either overheated buildings occurring, for example due to warm winds or temporarily insufficient heating due to the outdoor sensor being exposed to direct sunshine. In the operating level, the outdoor temperature blinks on the display while delayed outdoor temperature adaptation is active. A small hour glass appears next to the thermometer on the display when this function is active. The calculated outdoor temperature is displayed.

Functions	WE	Configuration
Delayed outdoor temperature adaptation (decreasing)	0	CO5 > F05 - 1 Delay/h: 1.0 to 6.0 °C
Delayed outdoor temperature adaptation (increasing)	0 3.0 °C	CO5 > F06 - 1 Delay/h: 1.0 to 6.0 °C

6.8 Remote Control Unit

In addition to measuring the room temperature, the EGT333F102 remote control unit also offers the option of setpoint correction: within nominal operation, the room setpoint can be lowered or raised by up to 8.5 K using a continuously variable rotary knob. The middle position is 21.5 °C.

When the room sensor is active, the measured room temperature value is displayed with the remote control connected and activated, but not used for control if neither Optimization, Adaptation or Short-Term Adaptation is activated.

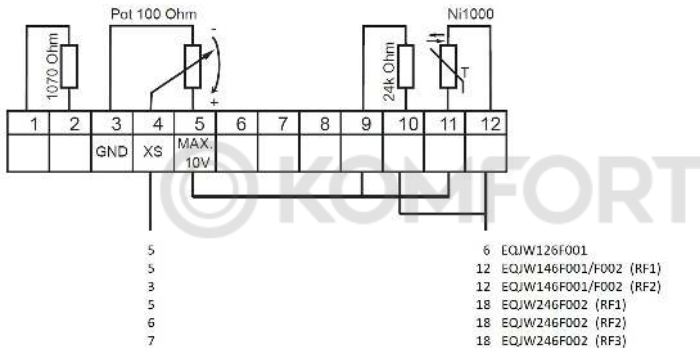

Functions	WE	Configuration
Room sensor	0	CO1, 2 > F01 - 1

6.9 Optimization

This function requires the use of a room sensor. Depending on the building characteristics, the controller determines and adapts the required advance heating time (maximum 8 hours) to ensure that the desired 'Day set point' (rated room temperature) has been reached in the reference room when the time-of-use starts. During the advance heating period, the controller heats with the max. flow temperature. This temperature is built up in steps of 10 °C. As soon as the 'Day set point' has been reached, outdoor-temperature-compensated control is activated.



Depending on the room sensor, the controller switches off the heating system up to one hour before the time-of-use ends. The controller chooses the deactivation time such that the room temperature does not drop significantly below the desired value until the time-of-use ends.

During the advance heating period and the premature deactivation of the heating system, the ✱ or Ⓒ icon blink on the display.

Outside the times-of-use, the controller monitors the 'Night set point' (reduced room temperature). When the temperature falls below the night set point, the controller heats with the max. flow temperature until the measured room temperature exceeds the adjusted value by 1 °C.

Note

- Direct sunshine can cause the room temperature to increase and thus result in the premature deactivation of the heating system.
- When the room temperature decreases while the heating system is shortly outside its times-of-use, this can prematurely cause the controller to heat up to the 'Day set point'.

Functions	WE	Configuration
Room sensor	0	CO1, 2 > F01 - 1
Outdoor sensor		CO1 > F02 - 1
Optimization	0	CO1, 2 > F07 - 1
Parameters	WE	Switch position: value range
Day set point	20.0 °C	 : 0.0 to 40.0 °C
Night set point	15,0 °C	 : 0.0 to 40.0 °C

6.10 Flash adaptation

To ensure that the controller reacts immediately to room temperature deviations during rated or reduced operation, the function block setting CO1, 2 > F09 - 1 needs to be made. The heating is then always switched off as soon as the room temperature exceeds the 'Day set point' or 'Night set point' by 2 °C.

Heating first starts again when the room has cooled off and the room temperature is 1 °C above the set point. The flow temperature set point is corrected if the 'Cycle time' and 'KP (gain)' are set to a value other than 0. The 'Cycle time' determines the intervals at which the flow temperature set point is corrected by 1 °C. A 'KP (gain)' set to a value other than 0 causes a direct increase/decrease in flow temperature set point when a sudden deviation in room temperature arises. A 'KP (gain)' setting of 10.0 is recommended.

Note

- Cooling loads, such as drafts or open windows, affect the control process.
- Rooms may be temporarily overheated after the cooling load has been eliminated.

Functions	WE	Configuration
Room sensor	0	CO1, 2 > F01 - 1
Flash adaptation	0 20 min 0.0	CO1, 2 > F09 - 1 Cycle time: 0 to 100 min KP (gain): 0.0 to 25.0
Parameters	WE	Switch position: value range
Day set point	20.0 °C	☀️: 0.0 to 40.0 °C
Night set point	15,0 °C	🌙: 0.0 to 40.0 °C

6.10.1 Flash adaptation without outdoor sensor (based on room temperature)

The flow temperature control starts with 'Day set point' for flow in rated operation or with 'Night set point' for flow in reduced operation as no set points calculated using characteristics exist without an outdoor sensor. The 'Cycle time' determines the intervals at which the flow temperature set point is corrected by 1 °C. The heating is then always switched off as soon as the room temperature exceeds the 'Day set point' or 'Night set point' by 2 °C. Heating first starts again when the room has cooled off and the room temperature is 1 °C above the set point. A 'KP (gain)' set to a value other than 0 causes a direct increase/decrease in flow temperature set point when a sudden deviation in room temperature arises. A 'KP (gain)' setting of 10.0 is recommended.

Functions	WE	Configuration
Room sensor	0	CO1, 2 > F01 - 1
Outdoor sensor		CO1 > F02 - 0
Flash adaptation	0 20 min 0.0	CO1, 2 > F09 - 1 Cycle time: 1 to 100 min KP (gain): 0.0 to 25.0
Parameters	WE	Switch position: value range
Day set point	20.0 °C	☀️: 0.0 to 40.0 °C
Night set point	15,0 °C	🌙: 0.0 to 40.0 °C
Parameters	WE	Parameters: value range
Flow set point (day)	50.0 °C	PA1, 2 > P03: -5.0 to 150.0 °C
Flow set point (night)	30.0 °C	PA1, 2 > P04: -5.0 to 150.0 °C

6.11 Adaptation

The controller is capable of automatically adapting the heating characteristic to the building characteristics, provided a gradient characteristic has been set (CO1, 2 > F11 - 0). The reference room, where the room sensor is located, represents the entire building and is monitored to ensure that the room set point ('Day set point') is maintained. When the mean measured room temperature in rated operation deviates from the adjusted set point, the heating characteristic is modified accordingly for the following time-of-use. The corrected value is displayed in PA1, 2 > P01 ('Flow gradient').

Functions	WE	Configuration
Room sensor	0	CO1, 2 > F01 - 1
Outdoor sensor		CO1 > F02 - 1
Adaptation	0	CO1, 2 > F08 - 1
Four-point characteristic	0	CO1, 2 > F11 - 0
Parameters	WE	Switch position: value range
Day set point	20,0 °C	☀: 0.0 to 40.0 °C
Night set point	15,0 °C	🌙: 0.0 to 40.0 °C

i Note

If the flash adaptation function is already configured with a small cycle time, the adaptation function should not be configured as well.

6.12 Cooling control

Cooling control with outdoor sensor

When the cooling control function is activated in a control circuit with outdoor sensor, the four-point characteristic of the corresponding control circuit is automatically activated and the operating direction of the control output is reversed. In PA1 and/or PA2 the four points for the course of the set point based on the outdoor temperatures can be adjusted separately for day and night mode. The 'Base point for return flow temperature' that can be adjusted with an active return flow sensor determines the point at which a minimum limitation of the return flow temperature starts: if the measured return flow temperature falls below this value, the flow temperature set point is raised. The four return flow temperature values in the four-point characteristic function have no effect.

Functions	WE	Configuration	
Outdoor sensor		CO1 > F02 - 1	
Cooling control	0	CO1, 2 > F04 - 1	
Four-point characteristic	0	CO1, 2 > F11 - 1	
Parameters	WE	Parameters: value range	
Outdoor temperature	Point 1	5.0 °C	PA1, 2 > P05: -50,0 bis 50,0 °C
	Point 2	15.0 °C	
	Point 3	25.0 °C	
	Point 4	30.0 °C	
Flow temperature	Point 1	20.0 °C	PA1, 2 > P05: -5.0 to 150.0 °C
	Point 2	15.0 °C	
	Point 3	10.0 °C	
	Point 4	5.0 °C	
Reduced flow temperature	Point 1	30.0 °C	PA1, 2 > P05: -5.0 to 150.0 °C
	Point 2	25.0 °C	
	Point 3	20.0 °C	
	Point 4	15.0 °C	
Base point for return flow temperature	65.0 °C	PA1, 2 > P13: 5.0 to 90.0 °C	

i Note

The limiting factors 'KP' of the return flow sensor (CO1, 2 > F03) functions apply during cooling control as well.

Cooling control without outdoor sensor

When the cooling control function is activated in a control circuit without outdoor sensor, only the adjustment limits for the day and night set points at the rotary switch as well as the 'Base point for return flow temperature' can be adjusted in PA1 and/or PA2.

Functions	WE	Configuration
Outdoor sensor		CO1 > F02 - 0
Cooling control	0	CO1, 2 > F04 - 1
Parameters	WE	Switch position: value range

Functions of the heating circuit

Flow set point (day)	50.0 °C	☀: -5.0 to 150.0 °C
Flow set point (night)	30.0 °C	☾: -5.0 to 150.0 °C
Parameters	WE	Parameters: value range
Min. flow temperature	20.0 °C	PA1, 2 > P06: -5.0 to 150.0 °C
Max. flow temperature	90.0 °C	PA1, 2 > P07: 5.0 to 150.0 °C
Base point for return flow temperature:	65.0 °C	PA1, 2 > P13: 5.0 to 90.0 °C

Note

- The limiting factors 'KP' of the return flow sensor (CO1, 2 > F03) functions apply during cooling control as well.
- The request for a signal by downstream control circuits or externally (when a pre-control circuit is used) is based on the maximum selection. Therefore, systems (e.g. system AnI 3.0) or systems in which the demand is requested using a 0 to 10 V signal are not suitable for transmitting the signal for required cooling. The 'Set point boost (pre-control circuit)' parameter can only generate higher and not lower set points in the pre-control circuit.

6.13 Differential temperature control

In systems AnI 1.0 and 16.0, the differential temperature control causes the delivery rate of pump UP1 to be adapted through the 0 to 10 V output depending on the difference between the secondary flow temperature and the secondary return flow temperature. In system AnI 1.0 the sensor input RūF2 is automatically activated for this purpose with the setting CO1 > F23 - 1. In system AnI 16.0, the sensor inputs VF2 and RūF2 are automatically activated. The KP (influence factor) determines how strongly the controller responds when the temperature deviates from the set point of the differential temperature control.

Functions	WE	Configuration
-----------	----	---------------

Differential temperature control	0	CO1 > F23 - 1
	20.0 °C	Set point of differential temperature control: 0.0 to 50.0 °C
	1.0	
	20 %	KP (influence factor): 0.1 to 10.0 Minimum speed: 0 to 100 %



7 Functions of the DHW circuit

7.1 DHW heating in the storage tank system

Start storage tank charging

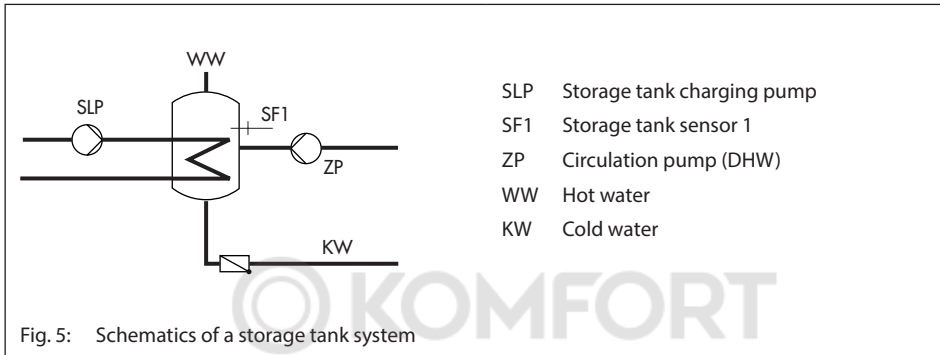

The controller begins charging the storage tank when the water temperature measured at storage tank sensor 1 falls below the 'DHW temperature set point' by 0.1 °C. If the flow temperature in the system exceeds the desired charging temperature, the controller tries to reduce the flow temperature in the heating circuit for up to three minutes before the storage tank charging pump is activated. When there is no heating operation or when the flow temperature in the system is lower, the storage tank charging pump is switched on immediately. If the function CO4 > F15 - 1 (SLP ON depending on return flow temperature) is activated, the primary valve is opened without simultaneously operating the storage tank charging pump. The storage tank charging pump is first switched on when the primary return flow temperature has reached the temperature currently measured at storage tank sensor 1. This function enables storage tank charging when the heating system is switched off, e.g. in summer mode, without cooling down the storage tank first by filling it with cold flow water. The storage tank charging pump does not start operation before a sufficiently high temperature has been reached at the heat exchanger.

i Note

The 'DHW temperature set point' is to be regarded in relation to the charging temperature if a storage tank thermostat is used.



Time-controlled switchover of storage tank sensors

By configuring a second storage tank sensor 2, it is possible to determine by setting the function block CO4 > F19 - 1 that the storage tank sensor 1 is used for day mode in the DHW circuit and storage tank sensor 2 for night mode. As a result, different storage tank volumes can be kept at a constant temperature according to a time schedule and also at different temperatures if the 'DHW temperature set points' for day and night differ from one another.

Stop storage tank charging

The controller stops charging the storage tank when the water temperature measured at storage tank sensor 1 has reached the temperature T = 'DHW temperature' + 'Hysteresis'. When there is no heating operation or when the flow temperature demand in the system is lower, the corresponding valve is closed. The storage tank charging pump is switched off after $t = \text{'Lag time of storage tank charging pump'} \times \text{'Valve transit time'}$.

With the default settings, the temperature in the storage tank is increased by 5 °C to reach 60 °C when the storage tank temperature falls below 55 °C. The charging temperature is calculated from the DHW temperature (55 °C) plus the 'Charging temperature boost' (10 °C), which equals 65 °C. When the storage tank has been charged, the heating valve is closed and the charging pump continues to run for the time $t = P06 \times \text{Valve transit time}$. Outside the times-of-use, the storage tank is only charged when the temperature falls below 40 °C ('Night set point for DHW temperature'). In this case, the tank is charged with a charging temperature of 50 °C until 45 °C is reached in the tank.

Functions	WE	Configuration
Storage tank sensor 1		CO4 > F01 - 1
Storage tank sensor 2		CO4 > F02 (-1 with CO4 > F19 - 1)
SLP depending on return flow temperature 0		CO4 > F15
Switchover	0	CO4 > F19 (-1 only when CO4 > F02 - 1)
Parameters	WE	Switch position: value range
Day set point for DHW temperature or charging temperature when CO4 > F01 - 0	60.0 °C	 Min. to max. adjustable DHW set point
Night set point for DHW temperature	40.0 °C	 Min. to max. adjustable DHW set point
Parameters	WE	Parameters: value range
Min. adjustable DHW set point*	40.0 °C	PA4 > P01: 5.0 to 90.0 °C
Max. adjustable DHW set point*	60.0 °C	PA4 > P02: 5.0 to 90.0 °C

Functions of the DHW circuit

Parameters	WE	Parameters: value range
Hysteresis**	5.0 °C	PA4 > P03: 0.0 to 30.0 °C
Parameters	WE	Parameters: value range
Charging temperature boost***	10.0 °C	PA4 > P04: 1.0 to 50.0 °C
Lag time for storage tank charging pump	1.0	PA4 > P06 x Valve transit time: 0.0 to 10.0

* Parameters serve as limitation of the adjustment range for the DHW temperature to be set at the rotary switch

** Deactivation value T = 'DHW temperature' + 'Hysteresis'

*** Charging temperature T = 'DHW temperature' + 'Charging temperature boost'

7.1.1 DHW circuit additionally controlled by a globe valve

In system An1 11.1, the following version with globe valve can be configured instead of the three-way valve control in the DHW circuit:

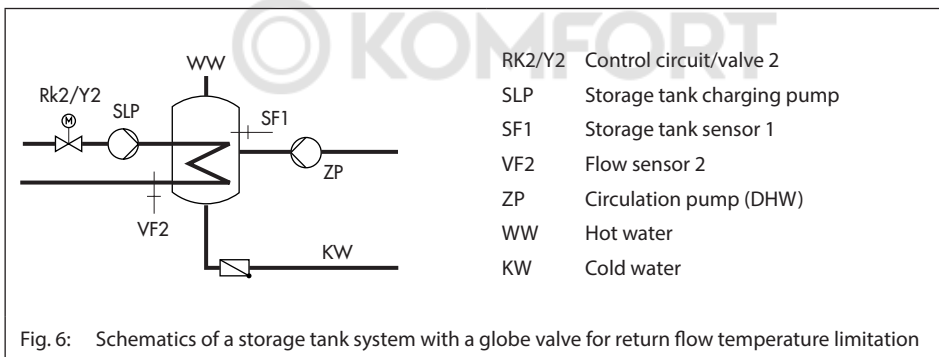

Globe valve and flow sensor VF2 are used exclusively for return flow temperature limitation in the schematics shown above. The pre-control circuit provides at least the same flow temperature as in the standard schematic version which is calculated from 'DHW temperature set point' + 'Charging temperature boost' + 'Boost set point (pre-control circuit)'.

The functions and parameters of the DHW heating in the storage tank system are upgraded by the following settings:

Functions	WE	Configuration
Return flow control	0	CO4 > F20 - 1
Parameters	WE	Parameters: value range
Max. return flow temperature	65.0 °C	PA4 > P07: 20.0 to 90.0 °C

7.2 DHW heating in the storage tank charging system

Start storage tank charging

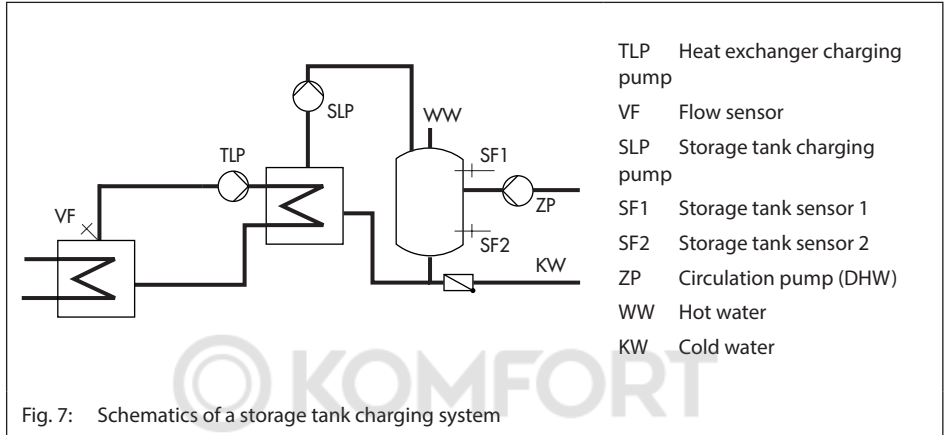

The controller begins charging the storage tank when the water temperature measured at storage tank sensor 1 falls below the 'DHW temperature set point' by 0.1 °C. If the flow temperature in the system exceeds the desired charging temperature, the controller tries to reduce the flow temperature in the heating circuit for up to three minutes before the exchanger charging pump is activated together with the storage tank charging pump. When there is no heating operation or when the flow temperature in the system is lower, the exchanger charging pump is switched on immediately. If the temperature currently measured at storage tank sensor 1 is reached at the flow sensor VF or after three minutes at the latest, the storage tank charging pump is switched on. If a storage tank thermostat is used, the storage tank charging pump is switched on when the temperature $T = \text{Charging temperature} - 5\text{ °C}$ is reached at the flow sensor VF.

i Note

The 'DHW temperature set point' is to be regarded in relation to the charging temperature if a storage tank thermostat is used.

When the flow sensor VF4 is activated, the set point in the heat exchanger circuit is influenced by the system deviation in the storage tank charging circuit upon activation of the storage tank charging pump: if the temperature measured at flow sensor VF4 is lower than the desired 'Charging temperature', the set point in the heat exchanger circuit is increased in

steps of 1 °C. When the set point in the heat exchanger charging circuit reaches the 'Max. charging temperature', the set point is no longer increased. An "Err 4" error message is generated.

Note

The set point in the heat exchanger circuit which is valid at the end of the charging cycle will be used again at the beginning of the next cycle.

If times-of-use have been programmed for DHW heating, the 'DHW temperature set point' adjusted at the rotary switch is applied during these times-of-use. Outside the times-of-use, the night set point for DHW temperature is used. This does not apply when a storage tank thermostat is used.

Time-controlled switchover of storage tank sensors

By configuring a second storage tank sensor 2, it is possible to determine by setting the function block CO4 > F19 - 1 that the storage tank sensor 1 is used for day mode in the DHW circuit and storage tank sensor 2 for night mode. As a result, different storage tank volumes can be kept at a constant temperature according to a time schedule and also at different temperatures if the 'DHW temperature set points' for day and night differ from one another.

Stop storage tank charging

The controller stops charging the storage tank when the water temperature measured at storage tank sensor 2 has reached the temperature $T = \text{'DHW temperature'} + \text{'Hysteresis'}$. To do so, the heat exchanger charging pump is immediately switched off. When there is no heating operation or when the flow temperature demand in the system is lower, the corresponding valve is closed. The storage tank charging pump is switched off after the time has elapsed $t = P06 \times \text{valve transit time}$.

Functions	WE	Configuration
Storage tank sensor 1		CO4 > F01 - 1
Storage tank sensor 2		CO4 > F02 - 1
Flow sensor	0	CO4 > F05
Switchover	0	CO4 > F19
Parameters	WE	Switch position: value range
Day set point for DHW temperature or charging temperature when CO4 > F01 - 0	60.0 °C	 : Min. to max. adjustable DHW set point

Parameters	WE	Switch position: value range
Night set point for DHW temperature	40.0 °C	☾☽ Min. to max. adjustable DHW set point
Min. adjustable DHW set point*	40.0 °C	PA4 > P01: 5.0 to 90.0 °C
Max. adjustable DHW set point*	60.0 °C	PA4 > P02: 5.0 to 90.0 °C
Hysteresis**	5.0 °C	PA4 > P03: 1.0 to 30.0 °C
Charging temperature boost***	10.0 °C	PA4 > P04: 0.0 to 50.0 °C
Max. charging temperature	80.0 °C	PA4 > P05: 20.0 to 150.0 °C (only with VF4)
Lag time for storage tank charging pump	1.0	PA4 > P06: 0.0 to 10.0

* Parameters serve as limitation of the adjustment range for the DHW temperature to be set at the rotary switch

** Deactivation value T = 'DHW temperature' + 'Hysteresis'

*** Charging temperature T = 'DHW temperature' + 'Charging temperature boost'

7.2.1 Cold charging protection

In system Anl 1.1(-1), the cold charging protection function causes a storage tank charging to be started first when the primary flow temperature is sufficiently high enough. The CO4 > F22 - 1 setting automatically activates the input FG2 to measure the primary flow temperature. If the measured primary flow temperature is lower than the measured storage tank temperature (e.g. due too a supply line that has cooled down at the start of a storage tank charging), the heating circuit valve is only opened 10 % at first. The storage tank charging is not released in absolute priority operation until the primary flow temperature has risen enough as a result. Parallel operation must be additionally configured if it is required.

Functions	WE	Configuration
Cold charging protection	0	CO4 > F22 - 1
Parallel pump operation	0	CO4 > F06 - 1
	10 min	Cancel: 0 to 10 min
	40.0 °C	Temperature limit: 20.0 to 90.0 °C

7.3 DHW heating in instantaneous heating system

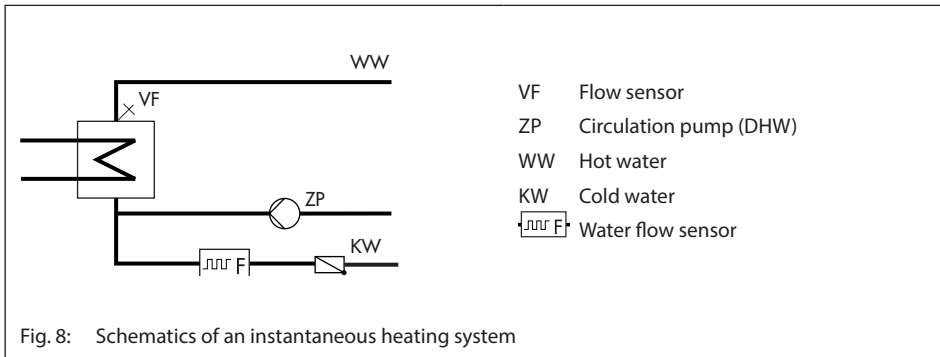

Without flow rate sensor or flow switch, the control of the required DHW temperature at the flow sensor VF is only active during times-of-use of the circulation pump ZP. The flow rate sensor or flow switch allows the controller to recognize when DHW tapping starts and stops. Control of the required DHW temperature can be made to be active only during DHW tapping by deleting all times-of-use of the circulation pump.

The control of the required DHW temperature at the flow sensor VF is only active during times-of-use of the circulation pump ZP.

Functions	WE	Configuration
Flow rate sensor	0 Analog	CO4 > F04 - 1 Selection: Analog (flow rate sensor), binary (flow switch)
Parameters	WE	Switch position: value range
Day set point for DHW temperature	60.0 °C	☀: Min. to max. adjustable DHW set point
Night set point for DHW temperature	40.0 °C	🌙: Min. to max. adjustable DHW set point
Parameters	WE	Parameters: value range
Min. adjustable DHW set point	40.0 °C	PA4 > P01: 5.0 to 90.0 °C
Max. adjustable DHW set point	60.0 °C	PA4 > P02: 5.0 to 90.0 °C

7.4 Domestic hot water heating with solar system

The systems An1 1.3 and 2.3 are fitted with a solar system for DHW heating. In these systems, the difference between the temperatures measured at storage sensor SF2 and the sensor at the solar collector VF3 is determined. The 'Solar circuit pump ON' parameter determines the minimum temperature difference between sensors VF3 and SF2 required to activate the solar circuit pump. If the temperature difference falls below the value of 'Solar circuit pump OFF', the solar circuit pump is switched off. Basically, the solar circuit pump is also switched off when either the water temperature measured at sensor SF2 has reached the 'Max. storage tank temperature' or when the solar collector temperature rises above 120 °C.

i Note

The times-of-use of the DHW circuit do not affect the operation of the solar system.

After the key number 1999 has been entered, the operating hours of the solar circuit pump are displayed in the extended operating level. See page 13.

Parameters	WE	Parameters: value range
Solar circuit pump ON	10.0 °C	PA4 > P10: 1.0 to 30.0 °C
Solar circuit pump OFF	3.0 °C	PA4 > P11: 0.0 to 30.0 °C
Max. storage tank temperature	80.0 °C	PA4 > P12: 20.0 to 90.0 °C

7.5 Intermediate heating

This function can only be activated in systems An1 2.x, 4.1 and 4.5.

With the setting CO4 > F07 - 1, heating operation of the UP1 heating circuit is reactivated for a period of 10 minutes after 20 minutes of priority operation (heating deactivated during DHW heating). By setting CO4 > F07 - 0, storage tank charging is given unlimited priority over the heating operation in the UP1 heating circuit.

Functions	WE	Configuration
Intermediate heating	1	CO4 > F07 - 1

7.6 Parallel pump operation

This function can only be activated in systems AnI 2.1 to 2.1, 4.1 and 4.5.

When $CO4 > F06 - 1$, the circulation pump UP1 remains activated during DHW heating.

This does not include operating situations during which the current flow temperature demand of the pump circuit is lower than the adjusted 'Temperature limit'. In this case, the controller applies priority operation, if necessary with intermediate heating. Once a parallel pump operation cycle has been activated and the time period set in 'Stop' has elapsed, system deviations greater than 5 °C cause the controller to suspend parallel operation for 10 minutes and to apply priority operation.

Setting 'Stop' to 0 min leads to a parallel operation once initiated remaining regardless of a deviation.

Functions	WE	Configuration
Parallel pump operation	0 10 min 40.0 °C	$CO4 > F06 - 1$ Stop: 0 to 10 min Temperature limit: 20.0 to 90.0 °C

7.7 Circulation pump during storage tank charging

With the setting $CO4 > F11 - 1$, the circulation pump (DHW) continues operation according to the programmed time schedule even during storage tank charging. With the setting $CO4 > F11 - 0$, the circulation pump is switched off as soon as the storage tank charging pump is activated. The circulation pump starts to operate again according to the time schedule when the storage tank charging pump has been switched off again.

Functions	WE	Configuration
Operation of circulation pump (DHW) during storage tank charging	0	$CO4 > F11$

7.8 Priority position

In many district heating systems with primary DHW heating, the allotted amount of water cannot meet DHW heating and heating operation demands when they are required at the same time. As a result, the capacity required for DHW heating needs to be taken from the heating system when great heating loads occur; and this, until DHW demand has been concluded. Nevertheless, heating operation is not to be interrupted simply. Only the amount of energy required for DHW heating is to be deducted. This can be achieved by using the priority functions: reverse control and set-back operation.

7.8.1 Reverse control

In all systems with DHW heating and at least one heating circuit with a control valve, DHW heating can be given priority by applying reverse control. With the setting $CO4 > F08 - 1$, the temperature is monitored at sensor VFx.

In systems without sensor VFx in the DHW circuit (e.g. Anl 4.5, 11.0), the temperature is monitored directly at storage tank sensor 1. If system deviations still occur after the time set in 'Start' has elapsed, the set point of the heating circuit with the control valve is gradually reduced each minute until the flow temperature set point has reached 5 °C at the minimum. How strongly the controller responds is determined by the 'KP' (influence factor).

When 'Start' is set to 0, the priority operation is started regardless of the time and temperature in the system. The control valve of the corresponding heating circuit is closed.

The reverse control can be activated for each heating circuit separately in system Anl 4.5.

Functions	WE	Configuration
Priority (reverse)	0	$CO4 > F08 - 1$
	2 min	Start: 0 to 10 min
	1.0	KP (influence factor): 0.1 to 10.0
	HC2	Control circuit: HC1, HC2, HC1+HC2 (only system Anl 4.5)
Priority (set-back)	0	$CO4 > F09 - 0$

7.8.2 Set-back operation

In all systems with DHW heating and at least one heating circuit with a control valve, DHW heating can be given priority by applying set-back operation. With the setting $CO4 > F09 - 1$, the temperature is monitored at sensor VFx in the DHW circuit.

In systems without sensor VFx in the DHW circuit (e.g. Anl 4.5, 11.0), the temperature is monitored directly at storage tank sensor 1. If system deviations still occur after the time set in 'Start' has elapsed, the selected heating circuit with the control valve is set to reduced operation.

When 'Start' is set to 0, the priority operation is started in all heating circuits regardless of the time and temperature in the system.

The reverse control can be activated for each heating circuit separately in system Anl 4.5.

Functions	WE	Configuration
Priority (reverse)	0	CO4 > F08 - 0
Priority (set-back)	0	CO4 > F09 - 1
	2 min	Start: 0 to 10 min
	HC2	Control circuit: HC1, HC2, HC1+HC2 (only system Anl 4.5)

7.9 Forced charging of DHW storage tank

To provide the full network performance for room heating when the time-of-use of the heating circuits begins, any storage tanks are charged one hour before the time-of-use of the heating circuits starts. For the individual controller, this means that storage tank charging is activated when the water temperature in the storage tank falls below the adjusted deactivation value of $T = \text{'DHW temperature'} + \text{'Hysteresis'}$.

The forced charging of the storage tank does not take place when the DHW circuit is not used at the beginning of the time-of-use set for the heating circuit(s).

Note

This function is not available when a storage tank thermostat is used.

7.10 Thermal disinfection of DHW storage tank

In all systems with DHW heating, a thermal disinfection is performed on a selected day of the week or daily.

- In systems with DHW storage tank, it is heated up, taking into account the Charging temperature boost parameter (or Set point boost, depending on the system) to the adjusted Disinfection temperature. Disinfection takes place within the adjusted time period ('Time').
- In systems with DHW heating in instantaneous heating system, the function remains active taking into account the Boost parameter until the circulation pipe, measured at storage tank sensor 1, has reached the adjusted Disinfection temperature, provided disinfection has not been terminated prematurely at the end of the adjusted time period (Time).

The 'Duration' determines how long the disinfection temperature must be maintained within the adjusted time period to rate the process successful. If the Duration is set to a value other than 0, no intermediate heating operation takes place during thermal disinfection.

When the 'Disinfection temperature' has not been reached before the end of the thermal disinfection cycle, it is indicated correspondingly on the display. This error message can also be

generated prematurely if the remaining time until the disinfection temperature is reached is shorter than the adjusted 'Duration'. The indication is automatically reset when the disinfection temperature is properly reached during the following thermal disinfection cycle.

Thermal disinfection for preventing legionella infection causes:

- Excessively high return flow temperatures during the disinfection cycle (return flow temperature limitation suspended)
- Excessively high DHW temperatures after thermal disinfection has been concluded
- Possibly lime scale, which can have a negative effect on heat exchanger performance.

i Note

This function is not available when a storage tank thermostat is used.

Functions	WE	Configuration
Storage tank sensor 1	1	CO4 > F01 - 1
Thermal disinfection	0	CO4 > F14 - 1
	Wednesday	Monday, Tuesday, ..., daily
	00:00 - 04:00	Time: Adjustable as required in steps of 15 minutes
	70.0 °C	Disinfection temperature: 60.0 to 90.0 °C
	10.0 °C	Boost: 0 to 50 °C
	0 min	Duration: 0 to 255 min
	ON	Active when BI =: ON, OFF (start of disinfection with terminal 03/12 = ON, OFF; only applies when Start time = Stop time)

8 System-wide functions

8.1 Automatic summer/standard time switchover

The time is automatically changed on the last Sunday in March at 2.00 h and on the last Sunday in October at 3.00 h.

Functions	WE	Configuration
Summer time	1	CO5 > F08 - 1

Note

The automatic summer/standard time switchover can also be programmed in the Time/date menu. See section 2.4.

8.2 Frost protection

Frost protection measures are taken when the outdoor temperature falls below 'Limit'. The switching differential to cancel the frost protection measures is always 1 °C.

Restricted frost protection: frost protection measures are taken only when all heating circuits in the system are in stand-by mode. The circulation pumps are automatically switched on and their flow temperature set points are adjusted to 10 °C. The circulation pump in the DHW circuit is automatically switched on only when the stand-by mode has been adjusted at the rotary switch in all heating circuits. Nevertheless, the storage tank is always recharged to 10 °C if the storage tank temperature falls below 5 °C.

Frost protection with highest priority: the heating circuit circulation pumps are always switched on automatically. The flow temperature set points of all heating circuits currently in stand-by mode are set to +10 °C. In the DHW circuit, the circulation pump is always activated. If the storage tank temperature falls below +5 °C, the storage tank is recharged to +10 °C.

Functions	WE	Configuration
Frost protection	3.0 °C	CO5 > F09 - 0: Restricted frost protection CO5 > F09 - 1: Frost protection with highest priority Limit: -15.0 to 3.0 °C

i Note

Frost protection operation of a pump, a heating circuit or the DHW circuit is only active when the ❄️ frost protection icon is displayed.

! NOTICE

System damage caused by frost!

In the stand-by mode (⊖) fixed set point control without outdoor temperature sensor does not include frost protection.

Do not switch off closed-loop operation for a long time during cold weather.

8.3 Forced pump operation

When the heating circuit pumps have not been activated for 24 hours, forced operation of the pumps is started between 12.02 h and 12.03 h. This is done to avoid that the pumps get stuck when they are not operated for long periods of time. In the DHW circuit, the circulation pump is operated between 12.04 h and 12.05 h, the other pumps between 12.05 h and 12.06 h.

8.4 Return flow temperature limitation

The temperature difference between the flow and return flow in a network indicates how well the energy is used: the greater the difference, the higher the efficiency. A return flow sensor is sufficient to evaluate the temperature difference when the flow temperatures are pre-defined. The return flow temperature can be limited either to a value depending on the outdoor temperature (variable) or to a fixed set point. When the return flow temperature measured at return flow sensor exceeds the limit, the flow temperature set point is reduced. When the temperature measured at return flow sensor RüF exceeds the return flow temperature limit, the set point of the flow temperature (flow temperature of the heating system, charging temperature) is reduced. This causes the primary flow rate to be reduced and the return flow temperature to drop. In systems AnI 2.x and 4.1, the 'Max. return flow temperature' parameter (PA4 level) is used for limitation in the primary circuit during DHW heating if it is greater than the parameter valid for the primary circuit. The KP (limiting factor) determines how strongly the controller responds when the limits are exceeded in either direction (PI algorithm).

If just the proportional component is to be implemented, set CO5 > F16-1. This allows the integral-action component in the return flow temperature limitation algorithm of all control cir-

System-wide functions

cuits of the controller to be deactivated. The set point reading (flow temperature of the heating, charging temperature) blinks to indicate that a return flow limitation is active in the control circuit concerned.

Note

When outdoor-temperature-compensated control with gradient characteristic is used, the return flow temperature is limited to a fixed value by equating the 'Base point for return flow temperature' and 'Max. return flow temperature' (PA1, 2 > P13 and P14) parameters.

Functions	WE	Configuration
Return flow sensor RüF1/2	1.0	CO1, 2, 4 > F03 - 1 KP (limiting factor): 0.1 to 10.0
Return flow temperature limitation with P algorithm*	0	CO5 > F16

* If the controller indicates CO5 > F00 - 1, any access to the return flow, flow rate and capacity settings is locked.

Parameters	WE	Parameters: value range
Return flow gradient	1.2	PA1, 2 > P11: 0.2 to 3.2
Return flow level	0.0 °C	PA1, 2 > P12: -30.0 to 30.0 °C
Base point for return flow temperature:	65.0 °C	PA1, 2 > P13: 5.0 to 90.0 °C
Max. return flow temperature	65.0 °C	PA1, 2, 4 > P14: 5.0 to 90.0 °C

or

Parameters	WE	Parameters: value range
Return flow temperature, points 1 to 4	65.0 °C	PA1, 2 > P05: 5.0 to 90.0 °C

Note

To ensure that the preset return flow temperature limit can be met, make sure that the heating characteristic is not adjusted to ascend too steeply, the speed of the circulation pumps is not set too high and the heating systems have been balanced.

8.5 Condensate accumulation control

Activate the damping function to start up condensate accumulation plants, in particular to avoid problematic excess temperatures. The controller response to set point deviations which cause the primary valve to open is attenuated. The controller response to set point deviations which cause the control valve to close remains unaffected.

i Note

The condensate accumulation control function can only be activated when the control circuit concerned is controlled using a PI algorithm (three-step control).

Functions	WE	Configuration
Control mode	1	CO1, 2, 4 > F12 - 1
Damping	0 3.0 °C	CO1, 2, 4 > F13 - 1 Max. system deviation: 3.0 to 10.0 °C

8.6 Three-step control

The flow temperature can be controlled using a PI algorithm. The valve reacts to pulses that the controller sends when a system deviation occurs. The length of the first pulse, in particular, depends on the extent of the system deviation and the selected 'KP (gain)' (the pulse length increases as KP increases). The pulse and pause lengths change continuously until the system deviation has been eliminated. The pause length between the single pulses is greatly influenced by the 'Tn (reset time)' (the pause length increases as TN increases). The 'TY (valve transit time)' specifies the time required by the valve to travel through the range of 0 to 100 %.

Functions	WE	Configuration
Control mode	1	CO1, 2, 4 > F12 - 1
	2.0	KP (gain): 0.1 to 50.0
	120 s	Tn (reset time): 1 to 999 s
	0 s	TV (derivative-action time): Do not change this value!
	35 s	TY (valve transit time): 15, ... , 240 s

8.7 On/off control

The flow temperature can be controlled, for example by activating and deactivating a boiler. The controller switches on the boiler when the flow temperature falls below the set point by $T = 0.5 \times \text{'Hysteresis'}$. When the set point is exceeded by $T = 0.5 \times \text{'Hysteresis'}$, the boiler is switched off again. The greater the value you choose for 'Hysteresis', the less frequent switching on and off will be. By setting the 'Minimum ON time', an activated boiler remains switched on during this period regardless of the flow temperature fluctuations. Similarly, a deactivated boiler will remain switched off regardless of the flow temperature fluctuations if the 'Min. OFF time' has been specified.

Functions	WE	Configuration
Control mode	1	CO1, 2, 4 > F12 - 0
	5.0 °C	Hysteresis: 1.0 to 30.0 °C
	2 min	Min. ON time: 0 to 10 min
	2 min	Min. OFF time: 0 to 10 min

8.8 Continuous control in control circuit RK1

The flow temperature in the control circuit RK1 can be controlled using a PID algorithm. The valve in RK1 control circuit receives an analog 0 to 10 V signal from the controller. When a system deviation occurs, 'KP (gain)' immediately causes the 0 to 10 V signal to change (the greater the KP, the greater the change). The integral component becomes effective with time: 'Tn (reset time)' represents the time which elapses until the integral component has changed the output signal to the same extent as the immediate change performed by the proportional component (the greater Tn is, the slower the rate of change will be). Due to the derivative component, any change of the system deviation is incorporated into the output signal with a certain gain (the greater TV is, the stronger the change will be).

Functions	WE	Configuration
Control mode	1	CO1 > F12 - 1
	2.0	KP (gain): 0.1 to 50.0
	120 s	Tn (reset time): 1 to 999 s
	0 s	TV (derivative-action time): 0 to 999 s
	35 s	TY (valve transit time): 5, ... , 240 s

8.9 Releasing a control circuit/controller with binary input

The release of an individual control circuit or the controller with the binary input only becomes effective when the respective control circuit is in automatic mode (☺ icon). The released control circuit always works in automatic mode; the deactivated control circuit behaves as if it were transferred to stand-by mode. It remains active, however, in any case for processing an external demand. The control circuit can be released by the binary input when the binary input is either a make contact ('Active when BI' = OFF) or a break contact ('Active when BI' = ON).

i Note

- In systems with downstream heating circuit without a valve (Anl 2.x, 4.x), BI1 only influences the operation of this heating circuit.
- In system Anl 3.0, BI1 influences the operation of the entire controller (except for processing an external demand).
- In buffer tank systems Anl 16.x, BI1 influences only the operation of the buffer tank charging circuit when 'Release control circuit' is configured.

Functions	WE	Configuration
Enable	0	CO1, 2 > F14 - 1
	ON	Active when BI = ON, OFF
Release controller	0	CO5 > F15 - 1
	ON	Active when BI = ON, OFF

8.10 Speed control of the charging pump

This function allows the delivery rate of the charging pump in systems with buffer tank (CO1 > F21-1) and in systems with DHW storage tank (CO4 > F21-1) to be varied based on the temperature. When this function is activated, the input SF2 is automatically activated. In combination with CO1 > F06 - 0 or CO4 > F02 - 0, this input is only used for speed control and not to stop the storage tank charging.

All storage tank charging actions start with the minimum delivery rate of the charging pumps. As soon as the charging temperature is nearly reached, the delivery rate of the charging pump is increased and the valve controls the flow rate. If the charging temperature drops 5 °C below its associated set point, the delivery rate is reduced again. At the latest when the temperature at SF2 has reached the 'Start' value to reduce the delivery rate, the lin-

System-wide functions

ear reduction of the delivery rate based on the temperature at SF2 starts. If the temperature at SF2 reaches the 'Stop' value to reduce the delivery rate, the charging pump runs again at the minimum delivery rate. Following the lag time, the charging pump is finally deactivated when the storage is fully charged.

Functions	WE	Configuration
Speed control of the charging pump	0	CO1 > F21 - 1 or CO4 > F21 - 1
	40.0 °C	Start speed reduction - SF2 limit: 5.0 to 90.0 °C
	50.0 °C	Stop speed reduction - SF2 limit: 5.0 to 90.0 °C
	20 %	Min. speed signal: 0 to 50 %
AA1 reverse	0	CO5 > F25 - 1
	0 %	Zero: 0 to 50 %

8.11 External demand processing

The controller can process binary or analog requests for an externally required signal by a more complex secondary system. A binary request can only be processed when the inputs SF2 or RF2 are not assigned to a sensor.

Note

Overheating may occur in the heating circuits of the primary controller without control valve.

Excessive charging temperatures in DHW circuits without control valve controlled by the primary controller are excluded when the default settings of the controller are used: while storage tank charging is active, no flow temperature higher than the charging temperature is used by the primary controller. Nevertheless, if the Priority for external demand function is activated, the external demand is also processed during storage tank charging.

Functions	WE	Configuration
Priority for external demand	0	CO4 > F16 - 1

Binary demand processing

Regardless of the operating mode set for control circuit RK1, except for manual mode, the controller regulates the flow temperature when either the binary input (terminals 03/12) is a make contact ('Active when BI' = OFF) or a break contact ('Active when BI' = ON) in control circuit RK1 to at least the adjusted flow temperature adjusted in PA1 > P10 ('Minimum flow temperature set point HC for binary demand processing').

Functions	WE	Configuration
Demand processing	0	CO1 > F15 - 1
Demand processing, 0 to 10 V	0	CO1, 2 > F16 - 0
Binary demand processing	0	CO1 > F17 - 1
	ON	Active when BI = ON, OFF
Parameters	WE	Parameters: value range
Minimum flow temperature set point HC for binary demand processing	40.0 °C	PA1 > P10: 5.0 to 150.0 °C

Demand processing, 0 to 10 V

Regardless of the operating mode (except for manual mode) of the control circuit affected, the controller regulates the flow temperature at least to the temperature corresponding with the 0 to 10 V signal connected to terminals 11/12.

Functions	WE	Configuration
Demand processing	0	CO1 > F15 - 1
Demand processing, 0 to 10 V	0	CO1, 2 > F16 - 1
	0 °C	Lower transmission range: 0 to 150 °C
	120 °C	Upper transmission range: 0 to 150 °C
Binary demand processing	0	CO1 > F17 - 0
Parameters	WE	Parameters: value range
Set point boost (pre-control circuit)	5.0 °C	PA1, 2 > P15: 0.0 to 50.0 °C

8.12 Capacity limitation in RK1

The capacity can be limited based on a pulse signal up to 800 pulse/h at BE2. Three different operating situations exist:

- A system with simultaneous room and DHW heating requires maximum energy.
- A system with a fully charged storage tank that is only used for room heating requires less energy.
- A system that suspends room heating during DHW heating requires less energy.

As a result, three different maximum limit values can be adjusted:

- Max. limit value to determine the absolute upper limit
- Max. limit value for heating to operate room heating only
- Max. limit value for DHW to operate DHW heating only

System-wide functions

In all systems without DHW heating or without heating circuit, only the Max. limit value for the capacity can be specified. If the 'Max. limit' or 'Max. limit for heating' parameter is set to AT, a four-point characteristic configured in CO1 > F11 - 1 allows the input of four capacity limits for outdoor-temperature-compensated capacity limitation in addition to the outdoor, flow and return flow temperature values.

All limits are adjusted as pulses per hour [pulses/h]. As the reading for the current pulse rate P [pulse/h] (-> extended operating level, key number 1999) is calculated based on the time interval between incoming pulses, the controller naturally cannot react immediately to every sudden capacity change in the system.

The flow set point of the control circuit RK1 is reduced when the pulse rate reaches the currently valid maximum limit. The Limiting factor determines how strongly the controller responds.

Example to determine the limit:

If a capacity of 30 kW is to be limited, the following limit must be set in a heat meter, which issues one pulse per kilowatt hour:

$$P = \frac{30 \text{ kW}}{1 \text{ kWh/pulse}} = 30 \text{ pulse/h}$$

Note

If the controller indicates CO5 > F00 - 1, any access to the return flow, flow rate and capacity settings is locked.

Functions	WE	Configuration
Capacity limitation in RK1	0	CO5 > F10 - 1
	15 pulse/h	Max. limit: AT to 800 pulse/h
	15 pulse/h	Max. limit for heating*: AT to 800 pulse/h
	15 pulse/h	Max. limit for DHW*: 1 to 800 pulse/h
	1.0	Limiting factor: 0.1 to 10.0
Capacity limitation in RK1 with meter bus	0	CO6 > F12 - 0

* Not in systems Anl. 1.0, 1.5-1.9, 3.0, 3.5, 3.9, 4.0, 10.x, 11.x and 16.x

8.13 Creep feed rate limitation with a binary input

It is possible to report to the controller when the creep feed rate has fallen below a certain level by using a limit switch of the primary valve connected to the terminals 04/12 or to input RüF1. Either the open ('Active when BI = OFF) or closed binary input ('Active when BI = ON) can be configured at terminals 04/12 to indicate that the creep feed rate has fallen below a certain level. Only the closed binary input at RüF1 can be processed. Shortly after the alert, the controller closes the valve RK1. As soon as the flow temperature falls below the set point by more than 5 °C after the valve has been closed, control operation is started again.

Functions	WE	Configuration
Creep feed rate limitation	0	CO5 > F12 - 1
	Binary	Switching mode: Binary (terminals 04/12), analog (RüF1)
	ON	Active when BI =: ON, OFF

8.14 Requesting a demand by issuing a 0 to 10 V signal

The controller can request a demand for the maximum flow set point (with boost, if need be) by issuing an analog 0 to 10 V signal for external demand. For this purpose, the 0 to 10 V output is used as an alternative to issuing the control signal.

Analog or binary demand processing can be integrated into the analog request for an external demand.

Functions	WE	Configuration
External demand	0	CO1 > F18 - 1
	0.0 °C	Lower transmission range: 0.0 to 150.0 °C
	120.0 °C	Upper transmission range: 0.0 to 150.0 °C
	0.0 °C	Boost: 0.0 to 30.0 °C

8.15 Connecting potentiometers for valve position input

The FG1 and FG2 inputs can be used to connect potentiometers, for example to input valve positions when a resistance room sensor is not configured in the control circuit concerned.

The measured values (in the measuring ranges from 0 to 2000 Ω) are displayed as measured value 9 (FG1) and 10 (FG2). They are available as Modbus data points.

Functions	WE	Configuration
Room sensor RF1, 2	0	CO1, 2 > F01 - 0

8.16 Locking manual level

To protect the heating system, this function can be used to lock the manual level. When this function has been activated, automatic mode is started when the rotary switch is set to in automatic mode.

Functions	WE	Configuration
Lock manual level	0	CO5 > F21 - 1

8.17 Locking the rotary switch

When this function has been activated, the controller remains in automatic mode regardless of the rotary switch position. The rotary switch can no longer be used to adjust the controller settings. It is still possible to enter the key number.

Functions	WE	Configuration
Lock rotary switch	0	CO5 > F22 - 1

8.18 Feeder pump operation

In systems Anl 3.0 and 16.1, the feeder pump UP1 only starts to operate in the default setting when a flow temperature demand of a secondary controller exists. If CO5 > F14 - 1 is configured, this is also the case when the control circuit RK2 requires heat.

Functions	WE	Configuration
Operation UP1	0	CO5 > F14 - 1

8.19 External demand for heat due to insufficient heat supply

An external heat source can be demanded using the 0 to 10 V output. The function block for a request for external demand CO1 > F18 - 1 is automatically set. The function block parameters allow the transmission range to be determined. When a system deviation in RK1 greater than 10 °C lasts longer than 30 minutes, a voltage signal corresponding to the actual demand is issued. At the same time, the RK1 valve is forced to close. After 30 minutes, the ex-

ternal demand for heat is canceled (0 V issued) and the control signal output in RK1 is enabled again.

Functions	WE	Configuration
Demand for external heat	0	CO1 > F20 - 1

8.20 Entering customized key number

To prevent the function and parameter settings being changed by unauthorized users, a customized key number can be added to the fixed service key number. You can set the customized key number to be between 0100 and 1900.

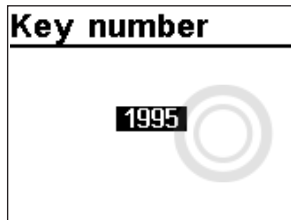

Turn the rotary switch to  (settings).

 Enter key number 1995.

* Confirm key number.

 Enter valid key number.

* Confirm key number.

 Enter customized key number.

* Confirm customized key number.

This number is the new key number.

Turn the rotary switch back to  (operating level).

9 Operational faults

A malfunction is indicated by the blinking  icon on the display. Additionally, the display is illuminated for one second every 10 seconds upon sensor failure. Press the rotary pushbutton to open the error level. As long as an error message is present, the error level is displayed, also when it has not been opened by pressing the rotary pushbutton.

In the error level, the error message is displayed as specified in the following list (section 9.1).

Note

After the system code number has been changed or after restarting the controller, any error messages are suppressed for approx. three minutes.

9.1 Error list

Sensor failure = Sensor failure (see section 9.2)

Disinfection = Disinfection temperature not reached (see section 7.10)

Max. charging temp. = Max. charging temperature reached (see section 7.2)

Temp. monitoring = Temperature monitor alarm (see section 9.3)

Unauthorized access = Unauthorized access occurred (see section 9.4)

Binary alarm = Error message of a binary input

Meter bus = Meter bus communication error

Heat meter = Heat meter error registered

Note

If the error messages or indications that can be confirmed are included in the list shown, you can decide whether you want to confirm these error messages on exiting the error list.

9.2 Sensor failure

As described in the error list, sensor failures are indicated by displaying 'Sensor failure' error message in the error level. For detailed information, exit the error level and view the different temperature values in the information level: each sensor icon displayed together with three dashes instead of the measured value indicates a defective sensor. The following list explains how the controller responds to the failure of the different sensors.

- Outdoor sensor AF1: When the outdoor sensor fails, the controller uses a flow temperature set point of 50 °C or the 'Max. flow temperature' when the max. flow temperature (PA1, 2 > P07) is lower than 50 °C. With the setting CO1, 2 > F05 - 1 (underfloor heating), the flow temperature set point is 30 °C in the event of a malfunction.
- Flow sensor(s) in heating circuit(s): When the flow sensors in the heating circuits are defective, the associated valve moves to 30 % travel. DHW heating using such a sensor to measure the charging temperature is suspended.
- Flow sensors in the DHW circuit with control valve: When the flow sensor VF4 fails, the controller behaves as if VF4 has not been configured. As soon as the control of the charging temperature becomes impossible (VF2 defective), the associated valve is closed.
- Return flow sensors RÜF1/2: When the return flow sensor fails, the controller continues operation without return flow temperature limitation.
- Room sensors RF1/2: When the room sensor fails, the controller uses the settings for operation without room sensor. The controller, for example switches from optimizing mode to reduced operation. The adaptation mode is canceled. The last determined heating characteristic remains unchanged.
- Storage tank sensors SF1/2: When one of the two sensors fails, the storage tank is no longer charged (exception: solar system).
- Solar circuit sensors SF3, VF3: When one of the two sensors fails, the storage tank in the solar circuit is no longer charged.

9.3 Temperature monitoring

When a system deviation greater than 10 °C persists in a control circuit for 30 minutes, an "Err 6" message (temperature monitoring alarm) is generated.

Functions	WE	Configuration
Monitoring	0	CO5 > F19 - 1

9.4 Error status register

The error status register is used to indicate controller or system errors. The error messages which cause a change in the state of the configured fault alarm output (CO5 > F07 - 1) are highlighted in the following table (bold).

Operational faults

In the CO8 configuration level, the binary inputs BI1 and BI2 can be added to the error status register. Either an open or closed binary input can be configured to indicate an error. The controller indicates 'Binary alarm' when at least one of the inputs configured in this way registers an error.

If free inputs are to issue binary signals to a building control station without affecting the error status register, activate the corresponding function block in the CO8 configuration level and select 'None' as the function block parameter.

Error message	Decimal value	
Sensor failure	1	1
-	2	
Disinfection	4	
Max. charging temp.	8	
External	16	
Temp. monitoring	32	32
Unauthorized access	64	
Binary alarm	128	
Meter bus	256	
Heat meter	512	
		Total
Example: Value of error status register when a sensor fails and a temperature monitoring alarm =		33

10 Communication

Using the optional controller EQJW126/146 communication module, the SAUTER EQJW146F002 Heating Controller can communicate with a control system. In combination with a suitable software for process visualization and communication, a complete control system can be implemented.

The following communication variants are possible:

- Operation with RS232C connection on communication module 0440210001 (1)
- Operation via RS485 two-wire bus at the communication module 0440210003 or 0440210004 (2)
- Operation via RS485 two-wire bus with cable converter 0440210012 (2)
- Operation with dial-up modem on communication module 0440210002 (3)
- Operation with Modbus GPRS gateway 0440210011 (4)
- Operation on a RS485 two-wire bus at the Modbus-MBus-gateway 0440210006 (5)
- Operation with LAN connection at Modbus TCP gateway 0440210005 (6)

In principle, automatic communication via a dial-up modem is only established if faults occur in the system. The controller operates autonomously, but can be dialed up, read out and, if necessary, influenced at any time over the modem.

As an alternative to the control station connection, the device bus allows direct data exchange between the controllers.

- Operation with device bus and communication modules, 0440210001 and 0440210002, 0440210003 and 0440210004 or with cable converter 0440210012

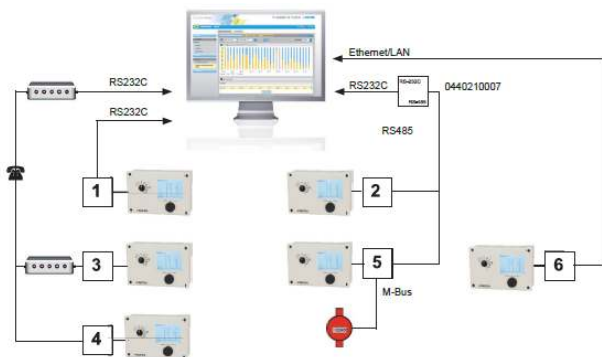

All communication modules are designed for operation at the communication interface coordinated. The interface properties cannot be parameterized.

Property	Setting
Baud rate	19200 Baud
Data bit, parity, stop bit	8 bits, none (no), 1 stop bit

For more details on the Communication accessory, refer to the Communication Connection Manual.

10.1 Memory module

A memory module (0440210010) is particularly useful for transferring all the set data from one EQJW146F002 controller to several other EQJW146F002 controllers.

Speichermodul
Einstellungen sichern
Einstellungen laden

The memory module is connected to the RJ-45 socket on the side. After connection, "Save settings" appears in the controller display. If the memory module already contains data from another SAUTER EQJW146F002 controller, the "Load settings" display can be called up by turning the control

- Pressing the control knob to confirm the "Save settings" display causes the controller setting to be transferred to the memory module.
- Press the rotary pushbutton to confirm "Load settings" to transfer the settings from the memory module to the controller.

Speichermodul

During the data exchange a ticker consisting of zeros and ones is displayed. After successful data transfer "Ok" appears in the display. The connection between controller and memory module can then be disconnected.

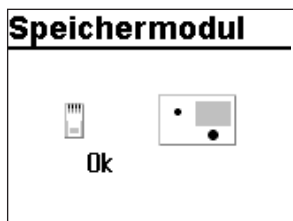

SAUTER-VIEW makes it possible to enter and document all the controller's setting values in plain text via PC.



11 Installation

The controller can be fitted with a standard base or with a high housing base.

Dimensions in mm (W x H x D)

- Controller with standard base: 144 x 98 x 54
- Controller with high base: 144 x 98 x 75

The controller consists of the housing with the electronics and the back panel with the terminals. It is suitable for panel, wall and top hat rail mounting (see Fig. 10).

Panel mounting

1. Undo the two screws (1).
2. Pull apart the controller housing and the base.
3. Make panel cut-out with the dimensions 138 x 92 mm (W x H).
4. Push the controller housing through the panel cut-out.
5. Tighten the two screws (2) to clamp the controller housing against the control panel.
6. Perform electric wiring on the base as described in section 12.
7. Remount the controller housing.
8. Fasten the two screws (1).

Wall mounting

1. Undo the two screws (1).
2. Pull apart the controller housing and the base.
3. If necessary, drill holes with the specified dimensions in the appropriate places. Fasten the back panel with four screws.
4. Perform electric wiring on the base as described in section 12.
5. Remount the controller housing.
6. Fasten the two screws (1).

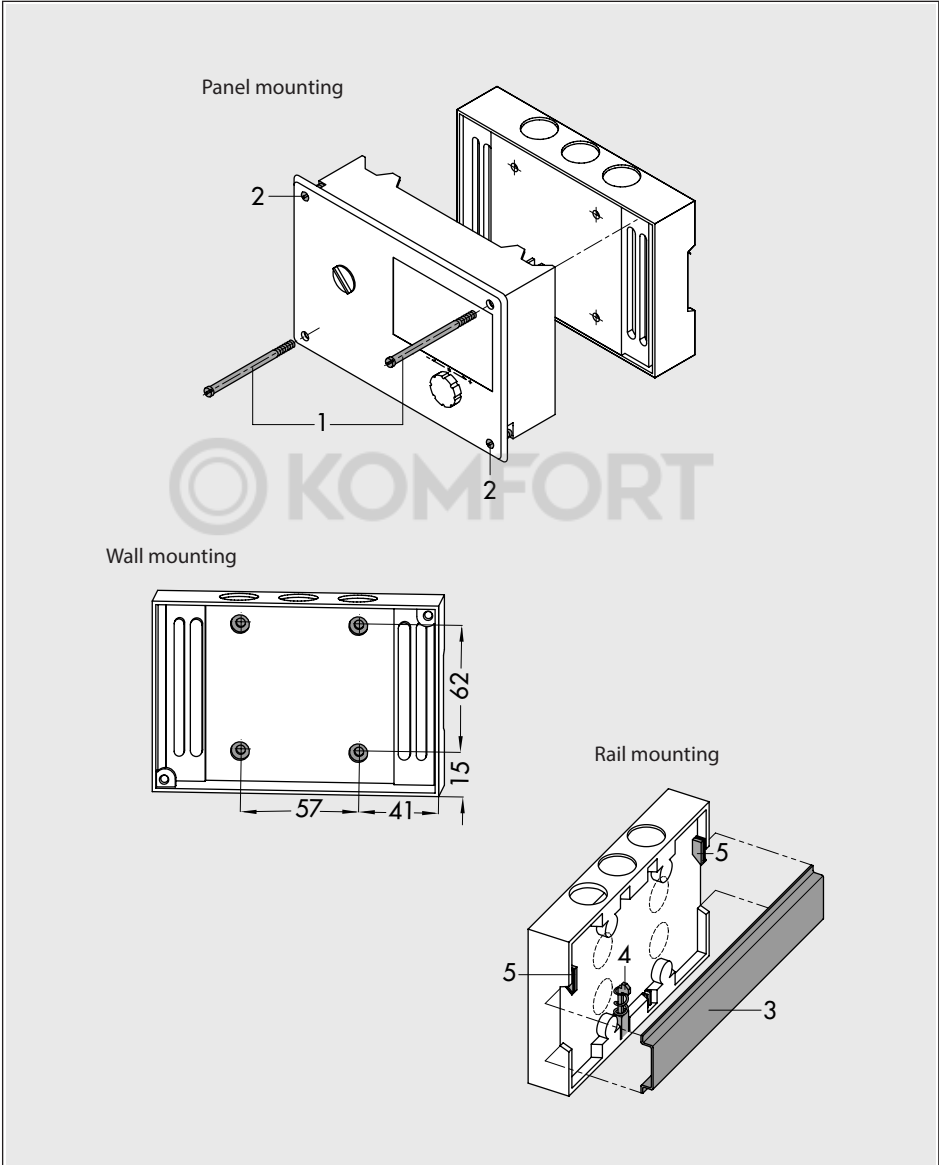

Fig. 9: Installation

Rail mounting

1. Fasten the spring-loaded hook (5) at the bottom of the top hat rail (3).
2. Slightly push the controller upwards and pull the upper hook (5) over the top hat rail. Undo the two screws (1).
3. Pull apart the controller housing and the base.
4. Perform electric wiring on the base as described in section 12.
5. Remount the controller housing.
6. Fasten the two screws (1).

12 Electrical connection

DANGER

Risk of electric shock!

- For electrical installation, you are required to observe the relevant electrotechnical regulations of the country of use as well as the regulations of the local power suppliers. Make sure all electrical connections are installed by trained and experienced personnel.
 - The terminals 20, 22, 25 and 28 allow safety equipment which have a direct influence on individual electric actuators and pumps to be integrated. If this is not the case, connect a jumper from terminal 18 to terminals 20, 22, 25 and 28. Do not connect ELV wiring (according to VDE 0100) to these terminals.
 - Before performing any work on the controller, disconnect it from the power supply.
-

Notes on electric wiring

- Install the 230 V power supply lines and the signal lines separately! To increase immunity, keep a minimum distance of 10 cm between the lines. Make sure the minimum distance is also kept when the lines are installed in a cabinet.
- The lines for digital signals (bus lines) and analog signals (sensor lines, analog outputs) must also be installed separately!
- In plants with a high electromagnetic noise level, we recommend using shielded cables for the analog signal lines. Ground the shield at one side, either at the control cabinet inlet or outlet, using the largest possible cross-section. Connect the central grounding point and the PE grounding conductor with a 10 mm² cable using the shortest route.

- Inductances in the control cabinet, e.g. contactor coils, are to be equipped with suitable interference suppressors (RC elements).
- Control cabinet elements with high field strength, e.g. transformers or frequency converters, must be shielded with separators providing a good ground connection.

Overvoltage protection

- If signal lines are installed outside buildings or over large distances, make sure appropriate surge or overvoltage protection measures are taken. Such measures are indispensable for bus lines.
- The shield of signal lines installed outside buildings must have current conducting capacity and must be grounded on both sides.
- Surge diverters must be installed at the control cabinet inlet.

Connecting the controller

Wall mounting

To connect the wiring, pull the controller out of its base. To connect the feeding cables, break through the holes in the marked locations at the top or bottom at the base housing and fit supplied grommets or suitable cable glands. Ensure that the cables are not subject to torsion or bending by taking suitable precautions before inserting the cable.

The controller is connected as illustrated in the following wiring diagrams.

Open the housing to connect the cables. To connect the feeding cables, make holes in the marked locations at the top, bottom or back of the base of the housing and fit suitable grommets or cable glands.

Connecting sensors

Cables with a minimum cross-section of $2 \times 0.5 \text{ mm}^2$ can be connected to the terminals at the base of the housing.

Connecting actuators

- 0 to 10 V control output: Use cables with a minimum cross-section of $2 \times 0.5 \text{ mm}^2$.
- Three-step or on/off outputs: Connect cables with at least 1.5 mm^2 suitable for damp locations to the terminals of the controller output. The direction of travel needs to be checked at start-up.

Connecting pumps

Connect all cables with at least 1.5 mm^2 to the terminals of the controller as illustrated in the wiring diagram.

i Note

The electric actuators and pumps are not automatically supplied with a voltage by the controller. They can be connected over terminals 20, 22, 25 and 28 to an external voltage source. If this is not the case, connect a jumper from terminal 18 to terminals 20, 22, 25 and 28.



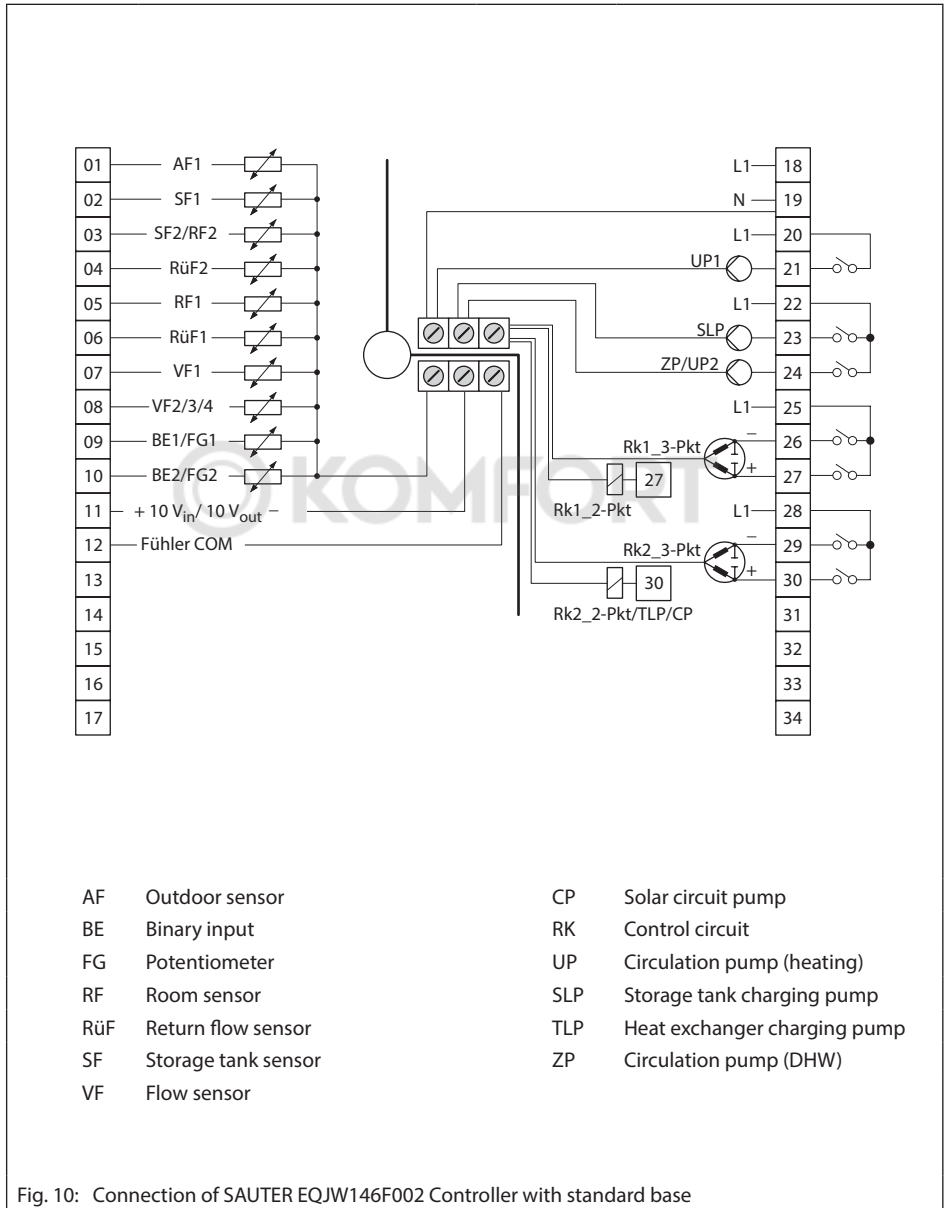

13 Appendix

13.1 Function block lists

CO1: RK1 · Heating circuit 1 (not system Anl 1.9)*

F	Function	WE	Anl	Comments Function block parameters: value range (default setting)
01	Room sensor	0	Not systems Anl. 1.5, 1.6, 3.x, 16.x	CO1 > F01 - 1: Room sensor RF1
02	Outdoor sensor	0	1.5, 1.6	CO1 > F02 - 1: Outdoor sensor AF1, outdoor-temperature-compensated control active
		1	Not Anl 1.5, 1.6	
03	Return flow sensor	0	1.2	CO1 > F03 - 1: Return flow sensor RÜF1, limitation function active Function block parameters: KP (limiting factor): 0.1 to 10.0 (1.0)
		1	Not Anl 1.2	
04	Cooling control	0	All*	CO1 > F04 - 1: Cooling control, only with CO1 > F11 - 1 The cooling control function causes a reversal of the operating direction and a minimum limitation of the return flow temperature in RK1.
05	Underfloor heating	0	Not systems Anl. 1.5, 1.6, 3.x, 16.x	CO1 > F05 - 1: Underfloor heating/drying of jointless floors Function block parameters: Start temperature: 20.0 to 60.0 °C (25 °C) Hold (days): 0 to 10 days (0 days) Temp. rise/day: 0.0 to 10.0 °C (5.0 °C) Maximum temperature: 25.0 to 60.0 °C (45.0 °C) Hold (days): 0 to 10 days (4 days) Temp. reduction/day: 0.0 to 10.0 °C (0.0 °C) Start condition: Stop, Start, Hold, Reduction
06	Storage tank sensor SF2	1	System Anl 16.x only	CO1 > F06 - 1: Activate SF2 to switch off charging of the buffer tank
07	Optimization	0	Not systems Anl. 1.5, 1.6, 3.x, 16.x	CO1 > F07 - 1: Optimization of heating times (only with CO1 > F01 - 1 and CO1 > F02 - 1)
08	Adaptation	0	Not systems Anl. 1.5, 1.6, 3.x, 16.x	CO1 > F08 - 1: Heating characteristic adaptation (only with CO1 > F01 - 1, CO1 > F02 - 1 and CO1 > F11 - 0)

F	Function	WE	Anl	Comments Function block parameters: value range (default setting)
09	Flash adaptation	0	Not systems Anl. 1.5, 1.6, 3.x, 16.x	CO1 > F09 - 1: Flash adaptation of flow temperature (only with CO1 > F01 - 1) Function block parameters: Cycle time: 0 or 1 to 100 min (20 min) KP (gain): 0.0 to 25.0 (0.0)
11	Four-point characteristic	0	Not Anl 1.5, 1.6	CO1 > F11 - 1: Four-point characteristic (only with CO1 > F08 - 0) CO1 > F11 - 0: Gradient characteristic
12	Control mode (three-step)	1	All*	CO1 > F12 - 1: Three-step control Function block parameters: KP (gain): 0.1 to 50.0 (2.0) Tn (reset time): 1 to 999 s (120 s) TV (derivative-action time): 0 to 999 s (0 s) TY (valve transit time): 15, ..., 240 s (35 s) CO1 > F12 - 0: On/off control Function block parameters: Hysteresis: 1.0 to 30.0 °C (5.0 °C) Min. ON time: 0 to 10 min (2 min) Min. OFF time: 0 to 10 min (2 min)
13	Damping	0	All*	CO1 > F13 - 1: OPEN signal damping (only with CO1 > F12 - 1) Function block parameters: Max. system deviation: 3.0 to 10.0 °C (3.0 °C)
14	Enable	0	All*	CO1 > F14 - 1: Release RK1 at BI1; FG1 has no function Function block parameters: Active when BI = ON, OFF (ON)
15	Demand processing	0	All*	CO1 > F15 - 1: Demand processing in RK1 Note: How the demand is processed depends on the configuration of CO1 > F16 and CO1 > F17.
16	Demand processing, 0 to 10 V Terminals 11/12	0	All*	CO1 > F16 - 1: Demand processing with 0 to 10 V signal (only with CO1 > F15 - 1 and CO1 > F17 - 0) Function block parameters: Lower transmission range: 0 to 150 °C (0 °C) Upper transmission range: 0 to 150 °C (120 °C)

Appendix

F	Function	WE	Anl	Comments Function block parameters: value range (default setting)
17	Binary demand processing Terminals 03/12	0	All*	CO1 > F17 - 1: Binary demand processing (only with CO1 > F15 - 1, CO1 > F16 - 0 and CO2 > F01 - 0 and CO4 > F02 - 0) Function block parameters: Active when BI = ON, OFF (ON)
18	External demand	0	All*	CO1 > F18 - 1: External demand 0 to 10 V The standardized signal output (terminals 11/12) is not available anymore as a control output. The maximum flow set point (with boost, if applicable) is demanded as a 0 to 10 V signal at the standardized signal output. Function block parameters: Lower transmission range: 0.0 to 150.0 °C (0.0 °C) Upper transmission range: 0.0 to 150.0 °C (120.0 °C) Boost: 0.0 to 30.0 °C (0.0 °C)
20	Demand for external heat	0	All	CO1 > F20 - 1: External demand for heat due to insufficient heat supply
21	Speed control of the charging pump	0	System Anl 16.x only	CO1 > F21 - 1: Temperature-based adaptation of the delivery rate of the charging pump Function block parameters: Start speed reduction - SF2 limit: 5.0 to 90.0 °C (40.0 °C) Stop speed reduction - SF2 limit: 5.0 to 90.0 °C (50.0 °C) Minimum speed: 0 to 50 % (20 %)
22	SLP depending on return flow temperature	0	System Anl 16.x only	CO1 > F22 - 1: Storage tank charging pump not ON unless return flow hot
23	Differential temperature control	0	Systems Anl 1.0, 16.0 only	CO1 > F23 - 1: Activation of differential temperature control Function block parameters: Set point of differential temperature control: 0.0 to 50.0 °C (20.0 °C) KP (influence factor): 0.1 to 10.0 (1.0) Minimum speed: 0 to 100 % (20 %)

F Function block number, WE Default setting, Anl System code number

CO2: RK2 · Heating circuit 2 (systems Anl 3.x, 4.x and 10.0, 16x)*

F	Function	WE	Anl	Comments Function block parameters: value range (default setting)
01	Room sensor	0	All*	CO2 > F01 - 1: Room sensor RF2
03	Return flow sensor	0	3.0, 4.x, 16.x	CO2 > F03 - 1: Return flow sensor RüF2; limitation function active Function block parameters: KP (limiting factor): 0.1 to 10.0 (1.0)
		1	10.x	
04	Cooling control	0	All*	CO2 > F04 - 1: Cooling control, only with CO2 > F11 - 1 The cooling control function causes a reversal of the operating direction and a minimum limitation of the return flow temperature in RK2.
05	Underfloor heating	0	All*	CO2 > F05 - 1: Underfloor heating/drying of jointless floors Function block parameters: Start temperature: 20 to 60 °C (25 °C) Hold (days): 0 to 10 days (0 days) Temp. rise/day: 0.0 to 10.0 °C (5.0 °C) Maximum temperature: 25.0 to 60.0 °C (45.0 °C) Hold (days): 0 to 10 days (4 days) Temp. reduction/day: 0.0 to 10.0 °C (0.0 °C) Start condition: Stop, Start, Hold, Reduction
07	Optimization	0	All*	CO2 > F07 - 1: Optimization of heating times (only with CO2 > F01 - 1 and CO2 > F02 - 1)
08	Adaptation	0	All*	CO2 > F08 - 1: Heating characteristic adaptation (only with CO2 > F01 - 1, CO1 > F02 - 1 and CO1 > F11 - 0)
09	Flash adaptation	0	All*	CO2 > F09 - 1: Flash adaptation of flow temperature (only with CO2 > F01 - 1) Function block parameters: Cycle time: 0 or 1 to 100 min (20 min) KP (gain): 0.0 to 25.0 (0.0)
11	Four-point characteristic	0	All*	CO2 > F11 - 1: Four-point characteristic (only with CO2 > F08 - 0) CO2 > F11 - 0: Gradient characteristic

F	Function	WE	Anl	Comments Function block parameters: value range (default setting)
12	Control mode (three-step)	1	All*	CO2 > F12 - 1: Three-step control Function block parameters: KP (gain): 0.1 to 50.0 (2.0) Tn (reset time): 1 to 999 s (120 s) TV (derivative-action time): 0 to 999 s (0 s) TY (valve transit time): 15, ..., 240 s (35 s) CO2 > F12 - 0: On/off control Function block parameters: Hysteresis: 1.0 to 30.0 °C (5.0 °C) Min. ON time: 0 to 10 min (2 min) Min. OFF time: 0 to 10 min (2 min)
13	Damping	0	All*	CO2 > F13 - 1: OPEN signal damping (only with CO1 > F12 - 1) Function block parameters: Max. system deviation: 3.0 to 10.0 °C (3.0 °C)
14	Enable	0	All*	CO2 > F14 - 1: Release RK2 at BI2; FG2 has no function Function block parameters: Active when BI = ON, OFF (ON)
16	Demand processing, 0 to 10 V Terminals 11/12	0	All*	CO2 > F16 - 1: Demand processing in RK2 Function block parameters: Lower transmission range: 0 to 150 °C (0 °C) Upper transmission range: 0 to 150 °C (120 °C)

F Function block number, WE Default setting, Anl System code number

CO4: DHW circuit (systems Anl 1.1–1.3, 1.5, 1.6, 1.9, 2.x, 4.1, 4.5, 11.x)*

F	Function	WE	Anl	Comments Function block parameters: value range (default setting)
01	Storage tank sensor 1	1	1.1–1.3, 1.5, 1.6, 2.x, 4.1, 4.5, 11.0, 11.2	CO4 > F01 - 1: Storage tank sensor SF1 CO4 > F01 - 0: Storage tank thermostat (only with CO4 > F02 - 0; not system Anl 11.0)
		0	1.9, 11.9	

F	Function	WE	Anl	Comments Function block parameters: value range (default setting)
02	Storage tank sensor 2	0	1.1, 1.3, 1.5, 2.0, 2.1, 2.3, 4.1, 4.5, 11.0, 11.1, 11.5	CO4 > F02 - 1: Storage tank sensor SF2 (only with CO4 > F01 - 1; not systems Anl 1.3, 1.9, 2.3, 11.0 and 11.9)
		1	1.2, 1.6, 2.2, 11.2	
03	Return flow sensor RüF2	0	1.9, 11.x	CO4 > F03 - 1: Return flow sensor RüF2; limitation function active Function block parameter: KP (limiting factor): 0.1 to 10.0 (1.0)
04	Water flow sensor	0	1.9, 11.9	CO4 > F04 - 1: Flow rate sensor at BI2 Function block parameter: Select: Analog/binary Binary = Flow switch at terminals 10/12
05	Flow sensor	0	1.1, 1.2, 1.6, 2.2	CO4 > F05 - 1: Flow sensor VF4 (to measure storage tank charging temperature)
06	Parallel pump operation	0	2.1–2.3, 4.1, 4.5	CO4 > F06 - 1: Parallel pump operation Function block parameters: Stop: 0 to 10 min (10 min) Temperature limit: 20.0 to 90.0 °C (40.0 °C) CO4 > F06 - 0: UP1 switched off during DHW heating
07	Intermediate heating	1	2.x, 4.1, 4.5	CO4 > F07 - 1: after 20 minutes of DHW heating, heating operation in UP1 circuit reactivated for 10 minutes CO4 > F07 - 0: storage tank charging is given unlimited priority concerning UP1 circuit
08	Priority (reverse)	0	1.1–1.3, 4.1, 4.5, 11.x	CO4 > F08 - 1: Priority by reverse control (only with CO4 > F09 - 0) Function block parameters: Start: 0 to 10 min (2 min) KP (influence factor): 0.1 to 10.0 (1.0) only system Anl 4.5: Control circuit: HC1, HC2, HC1+HC2 (HC2)

F	Function	WE	Anl	Comments Function block parameters: value range (default setting)
09	Priority (set-back)	0	1.1–1.3, 4.1, 4.5, 11.x	CO4 > F09 - 1: Priority through set-back operation (only when CO4 > F08 - 0) Function block parameters: Start: 0 to 10 min (2 min) Control circuit: HC1, HC2, HC1+HC2 (only system Anl 4.5)
10	Circulation pump (DHW) integrated into heat exchanger	0	1.6, 11.2	CO4 > F10 - 1: Control of DHW circuit active while circulation pump (ZP) is running
		1	11.6	
11	Operation of circulation pump (DHW) during storage tank charging	0	1.1–1.3, 1.5, 1.6, 2.x, 4.1, 4.5, 11.1, 11.2	CO4 > F11 - 1: Circulation pump (ZP) runs according to time schedule during storage tank charging CO4 > F11 - 0: Circulation pump (ZP) switched off during storage tank charging
12	Control mode	1	1.9, 11.x	CO4 > F12 - 1: Three-step control Function block parameters: KP (gain): 0.1 to 50.0 (2.0) Tn (reset time): 1 to 999 s (120 s) TV (derivative-action time): 0 to 999 s (0 s) TY (valve transit time): 15, ..., 240 s (35 s) CO4 > F12 - 0: On/off control Function block parameters: Hysteresis: 1.0 to 30.0 °C (5.0 °C) Min. ON time: 0 to 10 min (2 min) Min. OFF time: 0 to 10 min (2 min)
13	Damping	0	All*	CO4 > F13 - 1: OPEN signal damping (only with CO4 > F12 - 1) Function block parameters: Max. system deviation: 3.0 to 10.0 °C (3.0 °C)

F	Function	WE	Anl	Comments Function block parameters: value range (default setting)
14	Thermal disinfection	0	All*	CO4 > F14 - 1: Thermal disinfection (only with CO4 > F01 - 1) Function block parameters > Day of week: Monday, Tuesday, ..., daily (Wednesday) Time: Adjustable as required (00:00 – 04:00) Disinfection temperature: 60.0 to 90.0 °C (70.0 °C) Duration: 0 to 255 min (0 min) Active when BI = OFF, ON (ON) only possible with setting Start time = Stop time and without SF2/RF2. Input: terminals 03/12
15	SLP depending on return flow temperature	0	1.5, 2.0, 2.1, 2.3, 4.1, 11.1	CO4 > F15 - 1: storage tank charging pump not ON unless return flow hot (only with CO1 > F03 - 1 for systems Anl 1.5, 2.0, 2.1, 2.3, 4.1; only with CO4 > F03 - 1 for system Anl 11.1)
16	Priority for external demand	0	1.5, 1.6, 2.x, 4.1	CO4 > F16 - 1: Priority for external demand Note: a high external demand causes excessive charging temperatures in DHW circuits without control valve.
19	Switchover	0	1.1–1.3, 1.5, 1.6, 2.x, 4.1, 4.5, 11.1, 11.2	CO4 > F19 - 1: Switchover SF1, SF2 according to a time schedule. SF1 applies for day mode and SF2 for night mode (only with CO4 > F02 - 1)
20	Return flow control	0	11.1	CO4 > F20 - 1: DHW circuit additionally controlled by a globe valve
21	Speed control of the charging pump	0	1.1–1.3, 1.5, 1.6, 2.x, 4.1, 11.1, 11.2	CO4 > F21 - 1: Temperature-based adaptation of the delivery rate of the charging pump Function block parameters: Start speed reduction - SF2 limit: 5.0 to 90.0 °C (40.0 °C) Stop speed reduction - SF2 limit: 5.0 to 90.0 °C (50.0 °C) Min. speed signal: 0 to 50 % (20 %)
22	Cold charging protection	0	1.1	CO4 > F22 - 1: Storage tank charging started when the primary flow temperature is high enough

F Function block number, WE Default setting, Anl System code number

CO5: System-wide functions (all systems)

If the controller indicates CO5 > F00 - 1, any access to the return flow, flow rate and capacity settings is locked.

F	Function	WE	Anl	Comments Function block parameters: value range (default setting)
01	Sensor type	1	All*	CO5 > F01 - 1, F02 - 0: Pt 1000 CO5 > F01 - 0, F02 - 0: PTC CO5 > F01 - 1, F02 - 1: Ni 1000
02		1		
03		0		
04	Summer mode	0	Not systems Anl 1.5, 1.6, 1.9, 3.5	CO5 > F04 - 1: Summer mode Function block parameters: Time: Adjustable as required (01.06. - 30.09.) No. days until activation: 1 to 3 (2) No. days until deactivation: 1 to 3 (1) Limit: 0.0 to 30.0 °C (18.0 °C)
05	Delayed outdoor temperature adaptation (decreasing)	0	Not Anl 1.9	CO5 > F05 - 1: Delayed outdoor temperature adaptation as the temperature falls Function block parameters: Delay/h: 1.0 to 6.0 °C (3.0 °C)
06	Delayed outdoor temperature adaptation (increasing)	0	Not Anl 1.9	CO5 > F06 - 1: Delayed outdoor temperature adaptation as the temperature rises Function block parameters: Delay/h: 1.0 to 6.0 °C (3.0 °C)
07	Error message	0	Not Anl 4.1, 4.5, 11.1, 11.2, 11.3, 11.6, 16.1, 16.6	CO5 > F07 - 1: Terminal for error message: see plant scheme table Function block parameters: Relay contact = NO contact, NC contact (NO contact)
08	Summer time	0	All	CO5 > F08 - 1: Summer/standard time switchover
09	Frost protection	1	Not systems Anl 1.5, 1.6, 1.9, 3.5	CO5 > F09 - 1: Highest priority for frost protection Function block parameters: Limit: -15.0 to 3.0 °C (3.0 °C)
		0	1.5, 1.6, 1.9, 3.5	CO5 > F09 - 0: Restricted frost protection Function block parameters: Limit: -15.0 to 3.0 °C (3.0 °C)

F	Function	WE	Anl	Comments
				Function block parameters: value range (default setting)
10	Capacity limitation Input BI2	0	Not Anl 1.9	CO5 > F10 - 1: Capacity limitation in RK1 with pulses (only with CO6 > F12 - 0) Function block parameters: Max. limit: AT to 800 pulse/h (15 pulse/h) Max. limit for heating*: AT to 800 pulse/h (15 pulse/h) Max. limit for DHW*: 1 to 800 pulse/h (15 pulse/h) Limiting factor: 0.1 to 10.0 (1.0) *Not systems Anl. 1.0, 1.5-1.9, 3.0, 3.5, 4.0, 10.x, 11.x, 16.x
12	Creep feed rate limitation	0	Not Anl 1.9	CO5 > F12 - 1: Creep feed rate limitation Function block parameters: Switching mode: Binary, analog (binary) Active when BI = ON, OFF (ON)
14	Operation UP1	0	3.0, 16.x	CO5 > F14 - 1: Feeder pump UP1 operation to cover own demand Note: the feeder pump UP1 also starts to operate to cover the demand of RK2.
15	Enable	0	All	CO5 > F15 - 1: Release controller at BI1 Function block parameters: Active when BI = ON, OFF (ON)
16	Return flow temperature limitation (proportional controller)	0	All	CO5 > F16 - 1: Return flow temperature limitation with P algorithm
19	Monitoring	0	All	CO5 > F19 - 1: Temperature monitoring
20	Sensor calibration	1	All	CO5 > F20 - 1: Set all sensor calibration values CO5 > F20 - 0: Delete all sensor calibration values
21	Lock manual level	0	All	CO5 > F21 - 1: Lock rotary switch In  switch position, the controller runs in automatic mode
22	Lock rotary switch	0	All	CO5 > F22 - 1: Lock rotary switch Key number input is still possible.
23	0 to 10 V signal for outdoor temperature	0	All	CO5 > F23 - 1: Outdoor temperature received as 0 to 10 V signal or sent (terminals 11/12) Function block parameters: Direction: Input, Output (Input) Lower transmission range: -50.0 to 100.0 °C (-20.0 °C) Upper transmission range: -50.0 to 100.0 °C (50.0 °C)

Appendix

F	Function	WE	Anl	Comments Function block parameters: value range (default setting)
24	0-10 V input	0	All	CO5 > F24 - 1: The measured value at 0 to 10 V input is displayed as a special value.
25	AA1 reverse	0	All	CO5 > F25 - 0: 0 V/0 % = Valve CLOSED/pump OFF CO5 > F25 - 1: 0 V/0 % = Valve OPEN/pump with max. delivery rate Function block parameters: Zero: 0 to 50 % (0 %)
31	All Zero shift	0	All*	CO5 > F31 - 0 Function block parameters: Zero: 5 to 20 % (5 %)

F Function block number, WE Default setting, Anl System code number



CO6 > Modbus (all systems)

F	Function	WE	Anl	Comments Function block parameters: value range (default setting)
01	Modbus	1	All	CO6 > F01 - 1: Modbus active
02	16-bit address	0	All	CO6 > F02 - 1: Modbus 16-bit addressing (only with CO6 > F01 - 1) CO6 > F02 - 0: Modbus 8-bit addressing
03	Modem	0	All	CO6 > F03 ... F06 is required to configure the error message transfer to a connected Modbus/GPRS gateway (1402-0701).
04	Automatic configuration	0	All	
05	Lock dial-up to building automation system	0	All	
06	Dial-up also upon corrected error	0	All	
07	Monitoring	0	All	CO6 > F07 - 1: Control system monitoring > Resets all level bits to "autonomous" when there is no communication (only with CO6 > F01 - 1)
08	Text message	0	All	CO6 > F06 is required to configure the error message transfer to a connected Modbus/GPRS gateway (1402-0701).

F	Function	WE	Anl	Comments
				Function block parameters: value range (default setting)
20	Modbus without building automation system	0	All	CO6 > F20 - 1: Various Modbus specifications do not have any effect on the collective level/building automation system reading
				* Not systems Anl 1.0, 1.5–1.9, 3.0, 3.5, 4.0, 10.0, 11.x

F Function block number, WE Default setting, Anl System code number

CO7: Device bus (all systems)

F	Function	WE	Anl	Comments
				Function block parameters: value range (default setting)
01	Device bus	0	All	CO7 -> F01 - 1: Device bus active Function block parameters: Device bus address/Auto ¹⁾ , 1 to 32 (32) ¹⁾ Auto = Automatic search for a free device bus address in the system
02	Clock synchronization	0	All	CO7 -> F02 - 1: controller sends its system time to all device bus participants once every 24 hours
03	reserved		All	
04	reserved		All	
05	reserved		All	
06	Send AF1	0	All	CO7 -> F06 - 1: Function block parameters: Register number/1 to 4 (1)
07	Receive AF1	0	All	CO7 -> F07 - 1: Function block parameters: Register number/1 to 4 (1)
08	Send AF2	0	All	CO7 -> F08 - 1: Analysis active Function block parameters: Register number/1 to 4 (2)
09	Receive AF2	0	Not Anl 1.9	CO7 -> F09 - 1: Function block parameters: Register number/1 to 4 (2)
10	Send demand in HC1	0	All	CO7 -> F10 - 1: Send demand Function block parameters: Register number/5 to 64 (5)



11	Send demand in HC2	0	All	CO7 -> F11 - 1: Function block parameters: Register number/5 to 64 (5)
13	Send demand DHW	0	All	CO7 -> F13 - 1: 'Charging temperature boost' (P04) is generated in the PA4 level Function block parameters: Register number/5 to 64 (5)
14	Send max. demand	0	All	CO7 -> F14 - 1: the controller already determines internally the maximum flow set point of its circuit and sends it this value to the primary controllers
15	Receive external demand in HC1	0	All	CO7 -> F15 - 1: External demand processing in HC1 Function block parameters: Register number/5 to 64 (5)
16	Receive errors	0	All	CO7 -> F16 - 1: the controller generates the 'External' message as long as the faults of the other device bus participants exist.
17	Receive external demand in HC2	0	All	CO7 -> F17 - 1: External demand processing in HC2 Function block parameters: Register number/5 to 64 (5)
19	Raise return flow temperature	0	All	CO7 -> F19 - 1: Return flow temperature limit in HC1 raised when 'DHW heating active' message is received over the device bus Function block parameters: Register number/5 to 64 (32)
20	Send 'DHW heating active'	0	All	CO7 -> F20 - 1: Function block parameters: Register number/5 to 64 (32)
21	Receive release HC1	0	All	CO7 -> F21 - 1: Function block parameters: Register number/5 to 64 (32)
22	Receive release HC2	0	3.1-3.4, 4.x, 5.x, 6.x, 10.x, 16.1, 16.6, 16.8, 25.x	CO7 -> F22 - 1: Function block parameters: Register number/5 to 64 (32)

CO8 > Initialization of BI1 and BI2 (all systems)







F	Function	WE	Anl	Comments Function block parameters: value range (default setting)
01	Analysis of BI1	0	All	CO8 > F01 - 1: Analysis active Function block parameters: Error message when BI = 0, BI = 1, none (1)
02	Analysis of BI2	0	All	CO8 > F02 - 1: Analysis active Function block parameters: Error message when BI = 0, BI = 1, none (1)

13.2 Parameter lists



PA1: Heating circuit HC1

P	Display reading	Parameter: Value range (default setting)
01	P01  1.0	Flow gradient: 0.2 to 3.2 (1.8) 0.2 to 1.0 (1.0) with CO1 > F05 - 1
02	P02  0.0°C	Level (parallel shift): -30.0 to 30.0 °C (0.0 °C)
03	P03 50.0°C	Flow set point (day) (only with CO1 > F02 - 0 and CO1 > F09 - 1): -5.0 to 150.0 °C (50.0 °C)
04	P04 30.0°C	Flow set point (night) (only with CO1 > F02 - 0 and CO1 > F09 - 1): -5.0 to 150.0 °C (30.0 °C)

P	Display reading	Parameter: Value range (default setting)
05	<p> P05 4x4 grid: Row 1: -15°, -5°, 5°, 15° Row 2: 70°, 55°, 40°, 25° Row 3: 60°, 40°, 20°, 20° Row 4: 65°, 65°, 65°, 65° </p>	<p>Four-point characteristic</p> <p>Outdoor temperature: -50.0 to 50.0 °C (-15.0 °C, -5.0 °C, 5.0 °C, 15.0 °C) with CO1 > F04 -1: (5 °C, 15 °C, 25 °C, 30 °C)</p> <p>Flow temperature: -5.0 to 150.0 °C (70.0 °C, 55.0 °C, 40.0 °C, 25.0 °C) with CO1 > F04 -1: (20 °C, 15 °C, 10 °C, 5 °C)</p> <p>Reduced flow temperature: -5.0 to 150.0 °C (60.0 °C, 40.0 °C, 20.0 °C, 20.0 °C) with CO1 > F04 -1: (30 °C, 25 °C, 20 °C, 15 °C)</p> <p>Return flow temperature: 5.0 to 90.0 °C (65.0 °C, 65.0 °C, 65.0 °C, 65.0 °C)</p>
	<p> 4x4 grid: Row 1: -15°, -5°, 5°, 15° Row 2: 0.00, 0.00 Row 3: 0.00, 0.00 m³/h </p>	<p>Flow rate: 0.01 to 650 m³/h (0.00 m³/h, 0.00 m³/h, 0.00 m³/h, 0.00 m³/h)</p>
06	<p>P06 20.0°C</p>	<p>Min. flow temperature: -5.0 to 150.0 °C (20.0 °C)</p>
07	<p>P07 50.0°C</p>	<p>Max. flow temperature: 5.0 to 150.0 °C (90.0 °C) 5.0 to 50.0 °C (50.0 °C) with CO1 > F05 - 1</p>
09	<p>P09 -15.0°C</p>	<p>Outdoor temperature for continuous day mode: -50.0 to 5.0 °C (-15 °C)</p>
10	<p>P10 40.0°C</p>	<p>Minimum flow temperature set point HC for binary demand processing: 5.0 to 150.0 °C (40.0 °C)</p>
11	<p>P11 1.2</p>	<p>Return flow gradient: 0.2 to 3.2 (1.2)</p>
12	<p>P12 0.0°C</p>	<p>Return flow level: -30.0 to 30.0 °C (0.0 °C)</p>
13	<p>P13 65.0°C</p>	<p>Base point for return flow temperature: 5.0 to 90.0 °C (65.0 °C)</p>







P	Display reading	Parameter: Value range (default setting)
14	P14  65.0°C	Max. return flow temperature: 5.0 to 90.0 °C (65.0 °C)
15	P15  5.0°C	Set point boost (pre-control circuit): 0.0 to 50.0 °C (5.0 °C)
16	P16  AT	Minimum set point to charge buffer tank: OT to 90.0 °C (AT)
17	P17  AT	Stop charging of the buffer tank: OT to 90.0 °C (AT)
18	P18  6.0°C	Charging temperature boost: 0.0 to 50.0 °C (6.0 °C)
19	P19  1.0	Lag time of charging pump 0.0 to 10.0 (1.0)

PA2: Heating circuit HC2

P	Display reading	Parameter: Value range (default setting)
01	P01  1.0	Flow gradient: 0.2 to 3.2 (1.8) 0.2 to 1.0 (1.0) with CO2 > F05 - 1
02	P02  0.0°C	Level (parallel shift): -30.0 to 30.0 °C (0.0 °C)
03	P03 50.0°C	Flow set point (day) (only with CO2 > F02 - 0 and CO2 > F09 - 1): -5.0 to 150.0 °C (50.0 °C)
04	P04 30.0°C	Flow set point (night) (only with CO2 > F02 - 0 and CO2 > F09 - 1): -5.0 to 150.0 °C (30.0 °C)

P	Display reading	Parameter: Value range (default setting)																				
05	 <table border="1"> <tr> <td>↑</td> <td>-15°</td> <td>-5°</td> <td>5°</td> <td>15°</td> </tr> <tr> <td>▨</td> <td>70°</td> <td>55°</td> <td>40°</td> <td>25°</td> </tr> <tr> <td>▨</td> <td>60°</td> <td>40°</td> <td>20°</td> <td>20°</td> </tr> <tr> <td>↓</td> <td>65°</td> <td>65°</td> <td>65°</td> <td>65°</td> </tr> </table>	↑	-15°	-5°	5°	15°	▨	70°	55°	40°	25°	▨	60°	40°	20°	20°	↓	65°	65°	65°	65°	Four-point characteristic Outdoor temperature: -50.0 to 50.0 °C (-15.0 °C, -5.0 °C, 5.0 °C, 15.0 °C) with CO ₂ > F04 -1: (5 °C, 15 °C, 25 °C, 30 °C) Flow temperature: -5.0 to 150.0 °C (70.0 °C, 55.0 °C, 40.0 °C, 25.0 °C) with CO ₂ > F04 -1: (20 °C, 15 °C, 10 °C, 5 °C) Reduced flow temperature: -5.0 to 150.0 °C (60.0 °C, 40.0 °C, 20.0 °C, 20.0 °C) with CO ₂ > F04 -1: (30 °C, 25 °C, 20 °C, 15 °C) Return flow temperature: 5.0 to 90.0 °C (65.0 °C, 65.0 °C, 65.0 °C, 65.0 °C)
↑	-15°	-5°	5°	15°																		
▨	70°	55°	40°	25°																		
▨	60°	40°	20°	20°																		
↓	65°	65°	65°	65°																		
06	 20.0°C	Min. flow temperature: -5.0 to 150.0 °C (20.0 °C)																				
07	 50.0°C	Max. flow temperature: 5.0 to 150.0 °C (90.0 °C) 5.0 to 50.0 °C (50.0 °C) with CO ₂ > F05 - 1																				
09	 -15.0°C	Outdoor temperature for continuous day mode: -50.0 to 5.0 °C (-15 °C)																				
11	 1.2	Return flow gradient: 0.2 to 3.2 (1.2)																				
12	 0.0°C	Return flow level: -30.0 to 30.0 °C (0.0 °C)																				
13	 65.0°C	Base point for return flow temperature: 5.0 to 90.0 °C (65.0 °C)																				
14	 65.0°C	Max. return flow temperature: 5.0 to 90.0 °C (65.0 °C)																				
15	 5.0°C	Set point boost (pre-control circuit): 0.0 to 50.0 °C (5.0 °C)																				

PA4: Domestic hot water heating (DHW)

P	Display reading	Parameter: Value range (default setting)
01	P01  40.0°C	Min. adjustable DHW set point: 5.0 to 90.0 °C (40.0 °C)
02	P02  60.0°C	Max. adjustable DHW set point: 5.0 to 90.0 °C (90.0 °C)
03	P03  5.0°C	Hysteresis: 1.0 to 30.0 °C (5.0 °C)
04	P04  0.0°C	Charging temperature boost: 0.0 to 50.0 °C (10.0 °C)
05	P05 80.0°C	Max. charging temperature (only with CO4 > F05 - 1): 20.0 to 150.0 °C (80.0 °C)
07	P07 65.0°C	Max. return flow temperature: 20.0 to 90.0 °C (65.0 °C)
10	P10  10.0°C	Solar circuit pump ON: 1.0 to 30.0 °C (10.0 °C)
11	P11  3.0°C	Solar circuit pump OFF: 0.0 to 30.0 °C (3.0 °C)

13.3 Resistance values

Pt 1000

Temperature °C	-35	-30	-25	-20	-15	-10	-5	0	5	10	15	20
Resistance Ω	862.5	882.2	901.9	921.6	941.2	960.9	980.4	1000.0	1019.5	1039.0	1058.5	1077.9
Temperature °C	25	30	35	40	45	50	55	60	65	70	75	80
Resistance Ω	1097.3	1116.7	1136.1	1155.4	1174.7	1194.0	1213.2	1232.4	1251.6	1270.8	1289.9	1309.0
Temperature °C	85	90	95	100	105	110	115	120	125	130	135	140
Resistance Ω	1328.1	1347.1	1366.1	1385.1	1404.0	1422.9	1441.8	1460.7	1479.5	1498.3	1517.1	1535.8
Temperature °C	145	150	155	160	165	170	175	180	185	190	195	200
Resistance Ω	1554.6	1573.3	1591.9	1610.5	1629.1	1647.7	1666.3	1684.8	1703.3	1721.7	1740.2	1758.6

PTC

Temperature °C	-20	-10	0	10	20	30	40	50
Resistance Ω	693	756	824	896	971	1050	1133	1220

Temperature °C	60	70	80	90	100	110	120
Resistance Ω	1311	1406	1505	1606	1713	1819	1925

Ni 1000

Temperature °C	-60	-50	-40	-30	-20	-10	0	10	20	30	40
Resistance Ω	695	743	791	841	893	946	1000	1056	1112	1171	1230

Temperature °C	50	60	70	80	90	100	110	120	130	140	150
Resistance Ω	1291	1353	1417	1483	1549	1618	1688	1760	1833	1909	1986

Temperature °C	160	170	180	190	200	210	220	230	240	250
Resistance Ω	2066	2148	2232	2318	2407	2498	2592	2689	2789	2892

13.4 Technical data

Inputs	8 inputs for Pt 1000, PTC or Ni 1000 temperature sensors and 2 binary inputs, terminal 11 as 0 to 10 V input (e.g. for external demand or outdoor temperature signal)
Outputs* * Switch-on surge, max. 16 A	2 x three-step signal: load max. 250 V AC, 2 A*, alternatively 2 x on/off signal: load max. 250 V AC, 2 A* 3 x pump output: load max. 250 V AC, 2 A*, all outputs are relay outputs with varistor suppression Terminal 11 as 0 to 10 V output (e.g. for continuous closed loop control, outdoor temperature, signal for external demand or pump speed control), load >5 kΩ
Interfaces	M-bus for max. 3 M-bus units, protocol according to EN 1434-3
Optional interfaces	1 x Modbus RS-485 interface for two-wire bus using RS-485 communication module (Modbus RTU protocol, data format 8-N-1, RJ-45 connector socket at the side)
Operating voltage	85 to 250 V, 48 to 62 Hz, max. 1.5 VA
Ambient temperature	0 to 40 °C (operation), -10 to 60 °C (storage and transport)
Degree of protection	IP 40 according to IEC 529
Class of protection	II according to VDE 0106
Degree of contamination	2 according to VDE 0110
Overvoltage category	II according to VDE 0110
Humidity rating	F according to VDE 40040
Noise immunity	According to EN 61000-6-1
Noise emission	According to EN 61000-6-3
Weight	Approx. 0.5 kg
Compliance	

* For systems with one control circuit, a maximum of four pumps are available.

13.5 Customer setting

Station	
Operator	
SAUTER office	
System code number	

Function block settings in configuration levels

	CO1	CO2	CO4	CO5	CO6	CO8
F01						
F02						
F03						
F04						
F05						
F06						
F07						
F08						
F09						
F10						
F11						
F12						
F13						
F14						
F15						
F16						
F17						
F18						
F19						
F20						
F21						
F22						
F23						
F24						
F25						

Settings at the rotary switch · Set points

Parameters	Switch position 	Value range
HC1 room temperature		0.0 to 40.0 °C
HC2 room temperature		
DHW temperature		Min. to max. DHW temperature
HC1 OT deactivation value		0.0 to 50.0 °C
HC2 OT deactivation value		

Parameters	Switch position 	Value range
HC1 room temperature		0.0 to 40.0 °C
HC2 room temperature		
DHW temperature		Min. to max. DHW temperature
HC1 OT deactivation value		-50.0 to 50.0 °C
HC2 OT deactivation value		

Settings at the rotary switch · Times-of-use · Switch position 

Times-of-use HC1	Mon	Tue	Wed	Thu	Fri	Sat	Sun	Value range
Start first time-of-use								00:00 to 24:00 h
Stop first time-of-use								
Start second time-of-use								
Stop second time-of-use								
Start third time-of-use								
Stop third time-of-use								
Times-of-use HC2	Mon	Tue	Wed	Thu	Fri	Sat	Sun	Value range
Start first time-of-use								00:00 to 24:00 h
Stop first time-of-use								
Start second time-of-use								
Stop second time-of-use								
Start third time-of-use								
Stop third time-of-use								

Appendix

Times-of-use DHW	Mon	Tue	Wed	Thu	Fri	Sat	Sun	Value range
Start first time-of-use								00:00 to 24:00 h
Stop first time-of-use								
Start second time-of-use								
Stop second time-of-use								
Start third time-of-use								
Stop third time-of-use								
Times-of-use ZP	Mon	Tue	Wed	Thu	Fri	Sat	Sun	Value range
Start first time-of-use								00:00 to 24:00 h
Stop first time-of-use								
Start second time-of-use								
Stop second time-of-use								
Start third time-of-use								
Stop third time-of-use								

PA1 parameters (heating circuit HC1) and PA2 parameters (heating circuit HC2)

P	Parameters	PA1 (HC1)	PA2 (HC2)	Value range
01	Flow gradient			0.2 to 3.2
02	Level (parallel shift)			-30.0 to 30.0 °C
03	Flow set point (day)			-5.0 to 150.0 °C
04	Flow set point (night)			-5.0 to 150.0 °C
05	Four-point characteristic			
	Outdoor temperature, point 1			-50.0 to 50.0 °C
	Outdoor temperature, point 2			-50.0 to 50.0 °C
	Outdoor temperature, point 3			-50.0 to 50.0 °C
	Outdoor temperature, point 4			-50.0 to 50.0 °C
	Flow temperature, point 1			-5.0 to 150.0 °C
	Flow temperature, point 2			-5.0 to 150.0 °C
	Flow temperature, point 3			-5.0 to 150.0 °C
	Flow temperature, point 4			-5.0 to 150.0 °C
	Reduced flow temperature, point 1			-5.0 to 150.0 °C
	Reduced flow temperature, point 2			-5.0 to 150.0 °C
	Reduced flow temperature, point 3			-5.0 to 150.0 °C
	Reduced flow temperature, point 4			-5.0 to 150.0 °C
	Return flow temperature, point 1			5.0 to 90.0 °C
	Return flow temperature, point 2			5.0 to 90.0 °C

P	Parameters	PA1 (HC1)	PA2 (HC2)	Value range
05	Return flow temperature, point 3			5.0 to 90.0 °C
	Return flow temperature, point 4			5.0 to 90.0 °C
	Flow rate, point 1		–	0.01 to 650 m ³ /h
	Flow rate, point 2		–	0.01 to 650 m ³ /h
	Flow rate, point 3		–	0.01 to 650 m ³ /h
	Flow rate, point 4		–	0.01 to 650 m ³ /h
06	Min. flow temperature			–5.0 to 150.0 °C
07	Max. flow temperature			5.0 to 150.0 °C
09	Outdoor temperature for continuous day mode			–50.0 to 5.0 °C
10	Minimum flow temperature set point HC for binary demand processing			5.0 to 150.0 °C
11	Return flow gradient			0.2 to 3.2
12	Return flow level			–30.0 to 30.0 °C
13	Base point for return flow temperature:			5.0 to 90.0 °C
14	Max. return flow temperature			5.0 to 90.0 °C
15	Set point boost (pre-control circuit)			0.0 to 50.0 °C
16	Minimum set point to charge buffer tank		–	OT to 90.0 °C
17	Stop charging of the buffer tank		–	OT to 90.0 °C
18	Charging temperature boost		–	0.0 to 50.0 °C
19	Lag time of charging pump		–	0.0 to 10.0

CO1 function block parameters (heating circuit HC1) and CO2 function block parameters (heating circuit HC2)

F	Function block parameters	CO1 (HC1)	CO2 (HC2)	Value range
03	KP (limiting factor)			0.1 to 10.0
05	Start temperature			20.0 to 60.0 °C
05	Hold (days)			0 to 10 days
05	Temp. rise/day			0.0 to 10.0 °C
05	Maximum temperature			25.0 to 60.0 °C
05	Hold (days)			0 to 10 days
05	Temp. reduction/day			0.0 to 10.0 °C
05	Start condition			Start, Stop, Hold, Reduction
09	Cycle time			0 to 100 min

Appendix

F	Function block parameters	CO1 (HC1)	CO2 (HC2)	Value range
09	KP (gain)			0.0 to 25.0
12	KP (gain)			0.1 to 50.0
12	Tn (reset time)			1 to 999 s
12	TV (derivative-action time)			0 to 999 s
12	TY (valve transit time)			15 to 240 s
12	Hysteresis			1.0 to 30.0 °C
12	Min. ON time			0 to 10 min
12	Min. OFF time			0 to 10 min
13	Max. system deviation			3.0 to 10.0 °C
14	Active when BI =			ON, OFF
16	Lower transmission range			0.0 to 150.0 °C
16	Upper transmission range			0.0 to 150.0 °C
17	Active when BI =			ON, OFF
18	Lower transmission range		–	0.0 to 150.0 °C
18	Upper transmission range		–	0.0 to 150.0 °C
18	Boost			0.0 to 30.0 °C
21	Start speed reduction - SF2 limit		–	5.0 to 90.0 °C
21	Stop speed reduction - SF2 limit		–	5.0 to 90.0 °C
21	Minimum speed		–	0 to 50 %
23	Set point of differential temperature control		–	0.0 to 50.0 °C
23	KP (influence factor)		–	0.1 to 10.0
23	Minimum speed		–	0 to 100 %

PA4 parameters (domestic hot water heating)

P	Parameters	PA4 (DHW)	Value range
01	Min. adjustable DHW set point		5.0 to 90.0 °C
02	Max. adjustable DHW set point		5.0 to 90.0 °C
03	Hysteresis		1.0 to 30.0 °C
04	Charging temperature boost		0.0 to 50.0 °C
05	Max. charging temperature		20.0 to 150.0 °C
06	Lag time for storage tank charging pump		0.0 to 10.0 x valve transit time
07	Max. return flow temperature		20.0 to 90.0 °C
10	Solar circuit pump ON		0.0 to 30.0 °C
11	Solar circuit pump OFF		20.0 to 90.0 °C

P	Parameters	PA4 (DHW)	Value range
12	Max. storage tank temperature		20.0 to 90.0 °C
13	Maximum buffer tank temperature		20.0 to 90.0 °C
14	Control signal DHW for storage tank charging		5 to 100 %
19	Lag time for storage tank charging pump		0.0 to 10.0 (1.0)

CO4 function block parameters (domestic hot water heating)

F	Function block parameters	CO4 (DHW)	Value range
03	KP (limiting factor)		0.1 to 10.0
04	Select		Analog/binary
06	Stop		0 to 10 min
06	Temperature limit		20.0 to 90.0 °C
08	Start		0 to 10 min
08	KP (influence factor)		0.1 to 10.0
08	Control circuit (only system Anl 4.5)		HC1, HC2, HC1+HC2
09	Start		0 to 10 min
09	Control circuit (only system Anl 4.5)		HC1, HC2, HC1+HC2
12	KP (gain)		0.1 to 50.0
12	Tn (reset time)		1 to 999 s
12	TV (derivative-action time)		0 to 999 s
12	TY (valve transit time)		15 to 240 s
12	Hysteresis		1.0 to 30.0 °C
12	Min. ON time		0 to 10 min
12	Min. OFF time		0 to 10 min
13	Max. system deviation		3.0 to 10.0 °C
14	Day of the week		Monday to Sunday, daily
14	Time		Adjustable as required
14	Boost		60.0 to 90.0 °C
14	Duration		0 to 255 min
14	Active when BI =		ON, OFF
21	Start speed reduction - SF2 limit		5.0 to 90.0 °C
21	Stop speed reduction - SF2 limit		5.0 to 90.0 °C
21	Minimum speed		0 to 50 %
26	Zero point		0 to 50 %
31	Zero point		0.5 to 2 V

PA5 parameters (system-wide parameters)

P	Parameters	PA5	Value range
01	Start temperature for boiler pump		20.0 to 90.0 °C
02	Boiler pump hysteresis		0.0 to 30.0 °C

CO5 function block parameters (system-wide functions)

F	Function block parameters	CO5	Value range
04	Time		Adjustable as required
04	No. days until activation		1 to 3
04	No. days until deactivation		1 to 3
04	Limit		0.0 to 30.0 °C
05	Delay/h		1.0 to 6.0 °C
06	Delay/h		1.0 to 6.0 °C
07	Relay contact		NC contact, NO contact
09	Limit		-15.0 to 3.0 °C
10	Max. limit		OT to 800 pulse/h
10	Max. limit for heating		OT to 800 pulse/h
10	Max. limit for DHW		1 to 800 pulse/h
10	Limiting factor		0.1 to 10.0
12	Switching mode		Binary, analog
12	Active when BI =		ON, OFF
15	Active when BI =		ON, OFF
23	Direction		Input, Output
23	Lower transmission range		-50.0 to 100.0 °C
23	Upper transmission range		-50.0 to 100.0 °C
25	Zero point		0 to 50 %

PA6 parameters (Modbus)

P	Parameters	PA6	Value range
01	Modbus station address (8 bit)		1 to 246

CO6 function block parameters (Modbus)

F	Function block parameters	CO6	Value range
10	WMZ1 address		0 to 255
10	WMZ1 model code		1434, CAL3, APAtO, SLS
10	WMZ1 reading mode		24h, CONT, CoiL
10	WMZ2 address		0 to 255
10	WMZ2 model code		1434, CAL3, APAtO, SLS
10	WMZ3 reading mode		24h, CONT, CoiL
10	WMZ3 address		0 to 255
10	WMZ3 model code		1434, CAL3, APAtO, SLS
10	WMZ3 reading mode		24h, CONT, CoiL
11	Max. limit		OT, 0.01 to 650 m ³ /h
11	Max. limit for heating		OT, 0.00 to 650 m ³ /h
11	Max. limit for DHW		0.01 to 650 m ³ /h
11	Limiting factor		0.1 to 10
12	Max. limit		OT, 0.1 to 6500 kW
12	Max. limit for heating		OT, 0.0 to 6500 kW
12	Max. limit for DHW		0.1 to 6500 kW
12	Limiting factor		0.1 to 10
13	Max. limit		0.01 to 650 m ³ /h
13	Limiting factor		0.1 to 10
14	Max. limit		0.1 to 6500 kW
14	Limiting factor		0.1 to 10

CO8 function block parameters (initialization of BI1 and BI2)

F	Function block parameters	CO8	Value range
1	Error message when		BI = 0, BI = 1, none (1)
2	Limiting factor		BI = 0, BI = 1, none (1)



© KOMFORT

EQJW146F002

 **KOMFORT**

 **SAUTER**

SAUTER Deutschland
Sauter-Cumulus GmbH
Hans-Bunte-Str. 15
79108 Freiburg

<http://www.sauter-cumulus.de>

Telefon +49 (761) 5105-0

Telefax +49 (761) 5105-234

E-Mail: sauter-cumulus@de.sauter-bc.com